

Snake

modular system



Our mission is healthy light.

We create human and environment – friendly solutions: natural, comfortable to the eye, rendering genuine colours. We believe in timeless and universal aesthetics. We design lamps that are minimalist in their form, and which can complement both traditional and modern architecture. To draw up custom designs, we approach each interior from a fresh perspective.

Quality is at the core of our work. All of our products are manufactured in our own factory in Tarczyn, with the help of a team of lighting experts – technology and product engineers. For 20 years, we have completed a plethora of projects, and each of them represents how we understand the culture of light and the way light can be experienced in space. When considering the role of light in contemporary architecture, one cannot disregard the history of Bauhaus. The school, or rather a free, creative collective of architects, artists and artisans, is celebrating its centenary year.

Light was of the building blocks of architecture in Modernism. In those times, as a result of technological progress electric light became just as important building material as concrete or steel. Shaping the experience of space through artificial light in buildings was an entirely new challenge for Bauhaus architects and designers. Their avant-garde approach to materials and forms, combined with the consolidation of modernist standards in terms of aesthetics and form in the middle of the 20th century, became the foundation for contemporary design.

Today, when looking at Infinite numbers of light fixtures and lamps, it is easy to forget that today's lighting culture has its roots in the school of Bauhaus and owe sit its shape.



Snake

modular system

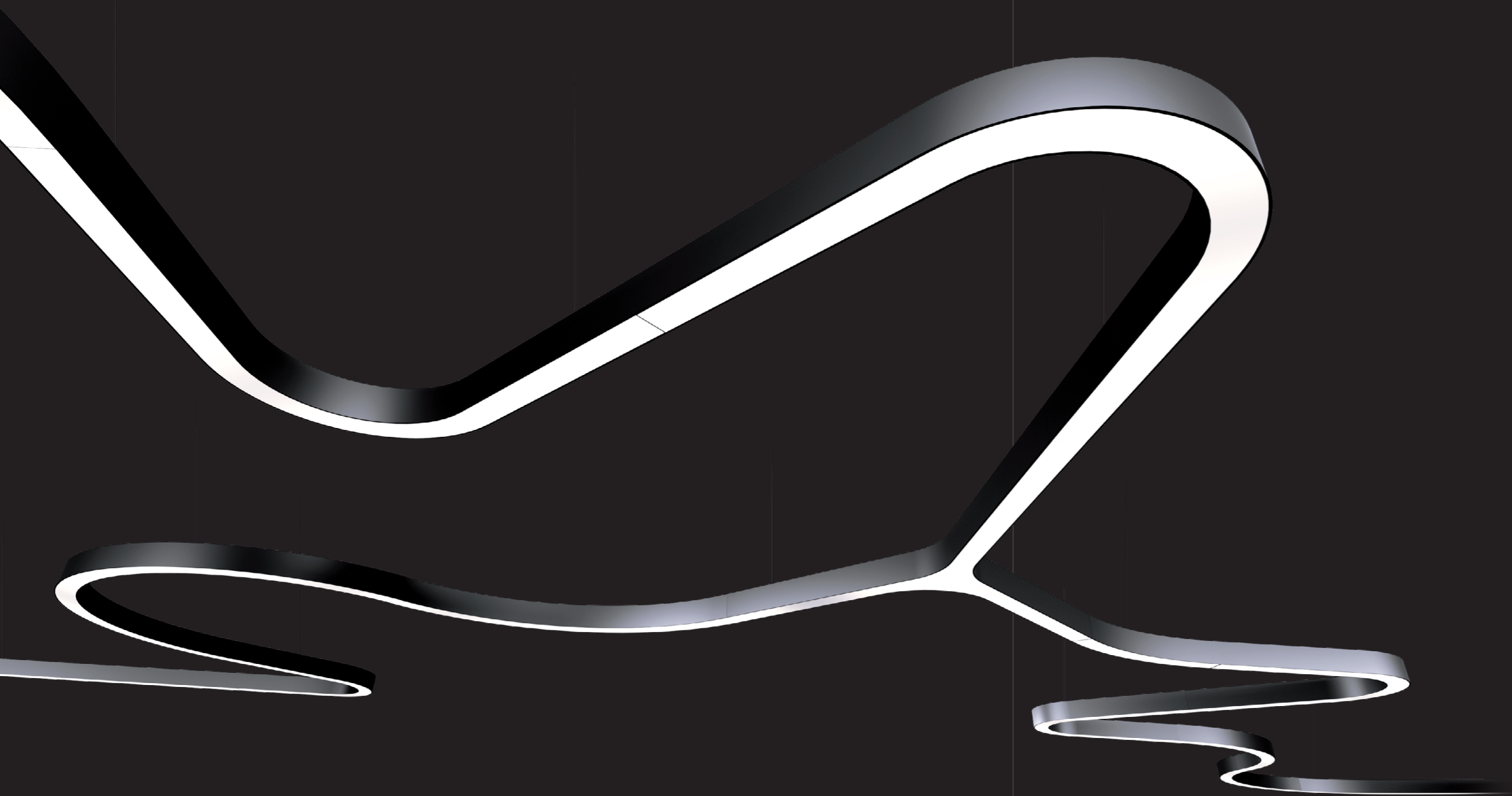

Nieskończone możliwości.

Nieregularne i opływowe linie zachęcają do spojrzenia w górę i podążania za nimi. Użyj różnych kształtów, kolorów i kilku krzywych okręgu, połącz je ze sobą i stwórz coś jedyne w swoim rodzaju.

Endless possibilities.

Irregular and streamlined lines will encourage you to look up and follow them. Use different shapes, colors and a several curves of the circle, connect them together and create something one of a kind.

Unendliche Möglichkeiten.

Unregelmäßige und gestraffte Linien werden Sie ermutigen, nach oben zu schauen und ihnen zu folgen. Verwenden Sie verschiedene Formen, Farben und mehrere Kurven des Kreises, verbinden Sie sie miteinander und schaffen Sie etwas Einzigartiges.







Cechy | Features | Eigenschaften



Montaż: nabudowany, zwieszany. **Źródło światła:** PCB LED, 3000 K / 4000 K, CRI > 80, MacAdam ≤ 3, 50000 h L80 B10. **Moc oprawy:** wersja high efficiency (HE) 15.3 W/m, wersja high output (HO) 30.5 W/m, oświetlenie punktowe 2.2 W/szt. (moduły CHILI), 4.7 W/szt. (moduły DART). **Strumień oprawy:** wersja high efficiency (HE) do 1758 lm/m, wersja high output (HO) do 3263 lm/m (dla dyfuzora mikrokrystalicznego), oświetlenie punktowe do 200 lm/szt. (moduły CHILI) lub do 435 lm/szt. (moduły DART). **Dyfuzory dla oświetlenia liniowego:** satynowy, mikrokrystaliczny, mikropryzmatyczny. **Optyka oświetlenia punktowego:** system by Bartenbach LFO 30°, 60° (moduły CHILI), 30°, 40° (moduły DART). **Rozsył światła:** bezpośredni (oświetlenie liniowe i punktowe), bezpośredni / pośredni (moduły oświetlenia liniowego). **Obudowa:** wytłaczany profil aluminiowy malowany proszkowo. **Sterowanie:** ON/OFF lub DALI.

Installation: Ceiling mounted, Suspended. **Light source:** LED PCB, 3000 K / 4000 K, CRI > 80, MacAdam ≤ 3, 50 000 h L80 B10. **Luminaire power:** high efficiency (HE) version 15.3 W/m, high output (HO) version 30.5 W/m, spots 2.2 W/pc (CHILI modules), 4.7 W/pc (DART modules). **Luminaire flux:** high efficiency (HE) version up to 1758 lm/m, high output (HO) version up to 3263 lm/m (for microcrystal diffuser), spots up to 200 lm/pc (CHILI modules) or up to 435 lm/pc (DART modules). **Diffuser for linear lighting:** satin, microcrystal, microprism. **Optic for spots:** system by Bartenbach LFO 30°, 60° (CHILI modules), 30°, 40° (DART modules). **Light distribution:** Direct (linear lighting and spots), Direct/Indirect (only linear lighting). **Body:** extruded aluminium profile, powder coated. **Control:** ON-OFF or DALI.

Colours:

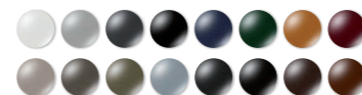

Installation: Deckenmontage, abgependelt. **Lichtquelle:** LED PCB, 3000 K / 4000 K, CRI > 80, MacAdam ≤ 3, 50 000 h L80 B10. **Leuchtenleistung:** hohe Effizienz (HE) Version 15.3 W/m, hohe Leistung (HO) Version 30.5 W/m, Spots 2.2 W/pc (CHILI Module), 4.7 W/pc (DART Module). **Lichtstrom:** Version mit hoher Effizienz (HE) bis zu 1758 lm/m, Version mit hoher Leistung (HO) bis zu 3263 lm/m (für mikrokrystall Diffusor), Spots bis zu 200 lm/pc (CHILI-Module) oder bis zu 435 lm/pc (DART-Module). **Diffusor für lineare Beleuchtung:** satiniert, Microcrystale, Mikroprisma. **Optik für Spots:** System von Bartenbach LFO 30°, 60° (CHILI-Module), 30°, 40° (DART-Module). **Lichtverteilung:** Direkt (lineare Beleuchtung und Spots), Direkt/Indirekt (nur lineare Beleuchtung). **Gehäuse:** Aluminium-Strangpressprofil, pulverbeschichtet. **Steuerung:** EIN-AUS oder DALI.

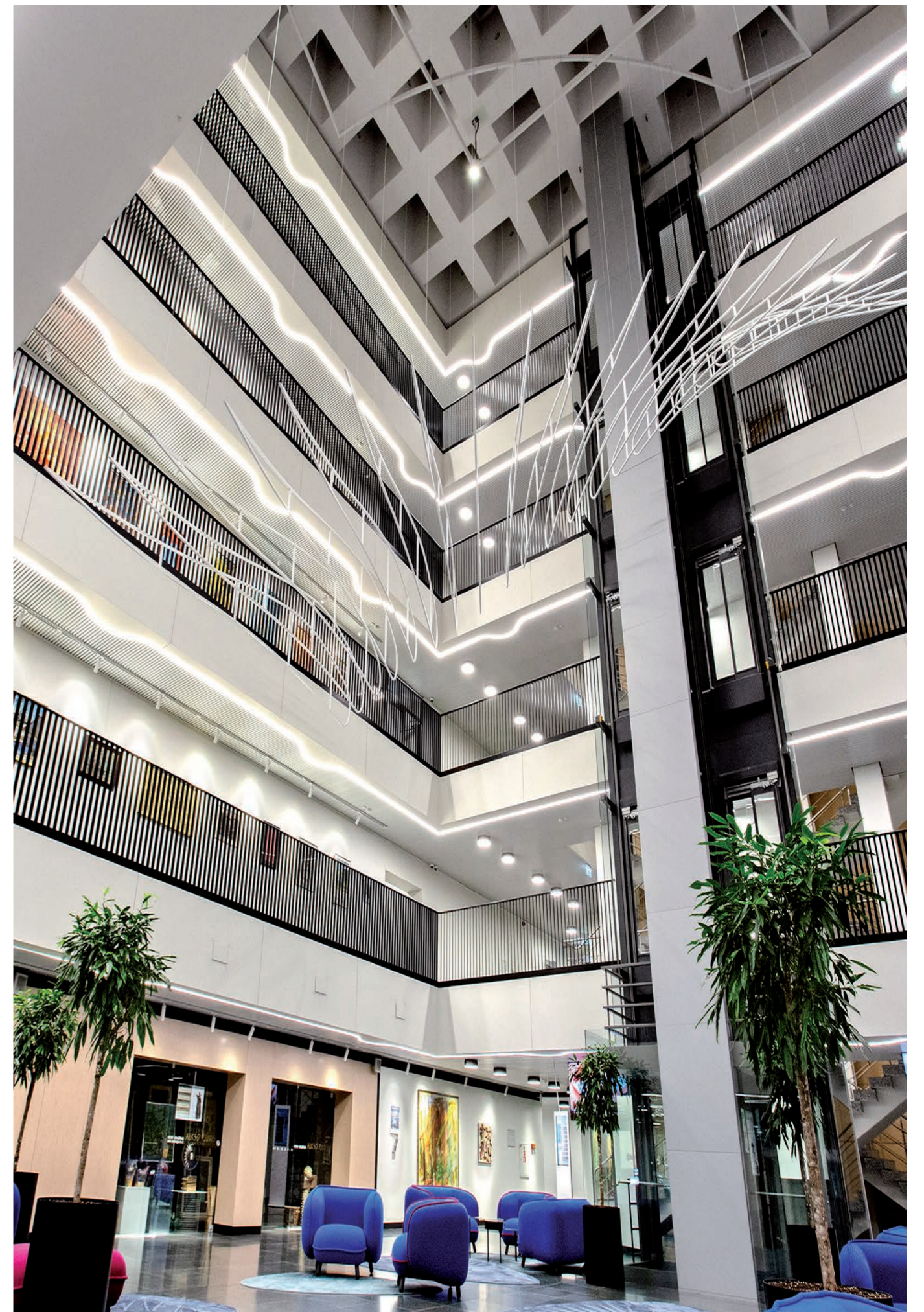

Snake Line

Nabudowany / Ceiling build-on / Deckenbefestigung
Zwieszany / Suspended / Abgehängt

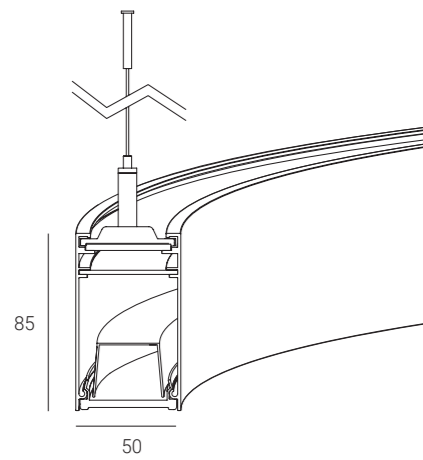
**Snake Chili**

Nabudowany / Ceiling build-on / Deckenbefestigung
Zwieszany / Suspended / Abgehängt

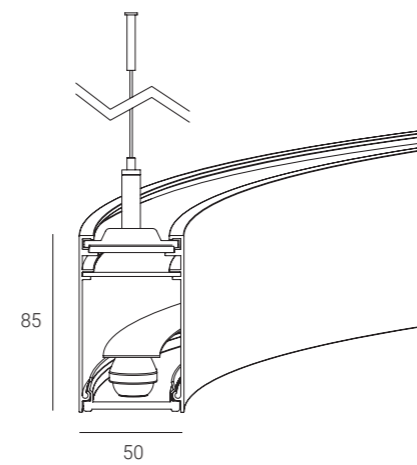
**Kolory**

Colors
Farben



white RAL 9016 fog RAL 7038 graphite RAL 7024 black RAL 9005



sapphire RAL 5003 forrest RAL 6005 ochra wine RAL 3005 sandy earth sage cloudy night black dust volcano marrone

Inne kolory dostępne na zamówienie.
Other colors available on demand.
Andere Farben sind auf Anfrage erhältlich.

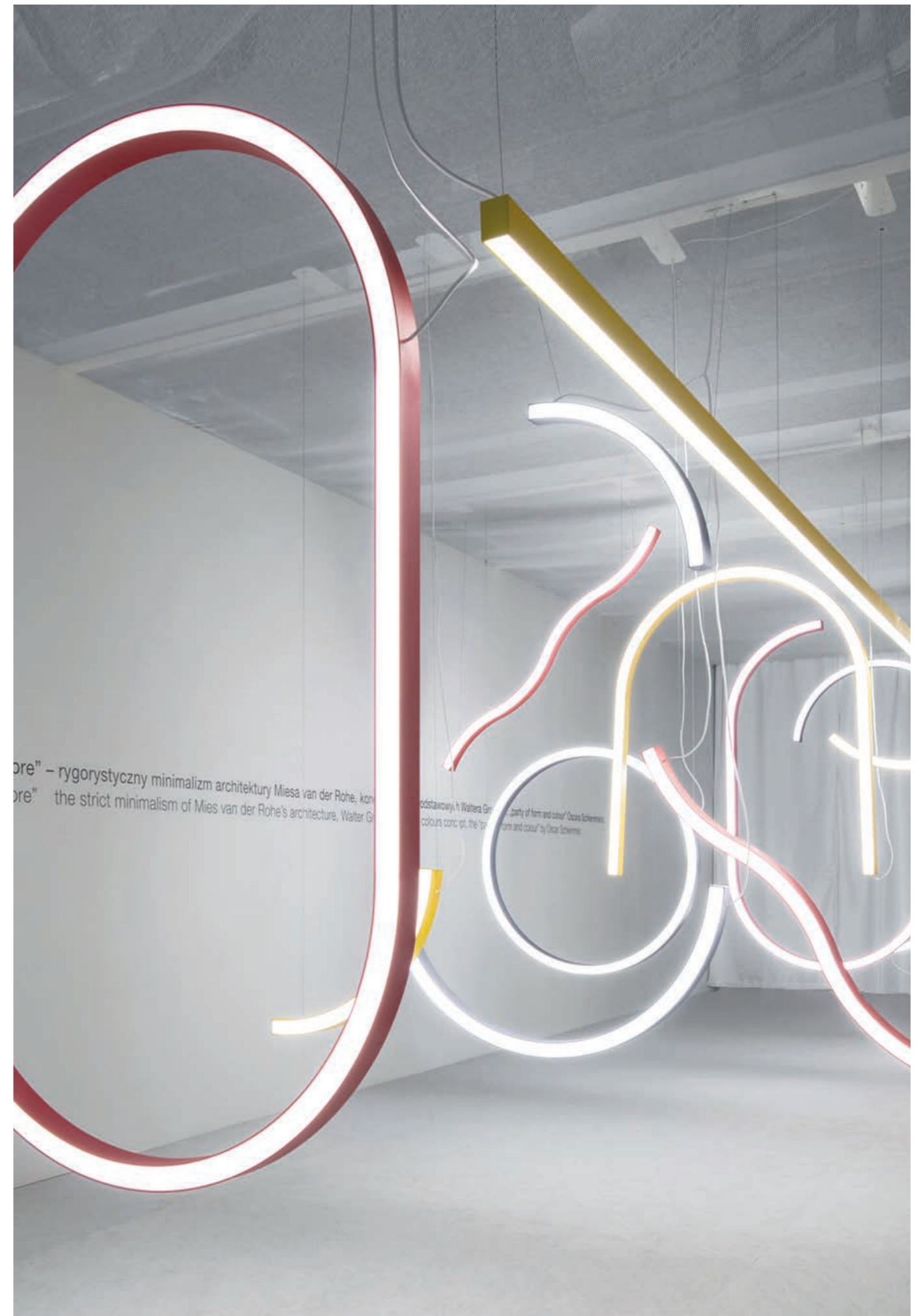



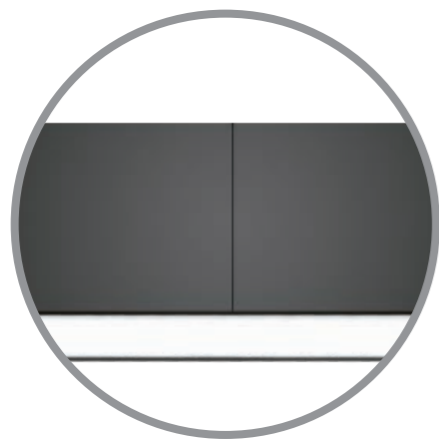

Łączenie profili w sposób eliminujący świecenie przez szczeliny.

Connection of profiles in a way that eliminates the risk of glowing through the gaps.

Die Profile sind in einer Weise verbunden, |die das Risiko des Leuchtens durch die Lücken ausschließt.



Dyfuzory ze złączem cover eliminują szczeliny na ich łączeniu.

Diffusers with overlapping joints eliminate gaps at their connection point.

Diffusore mit überlappenden Verbindungen eliminieren Spalten an ihrem Anschlusspunkt.

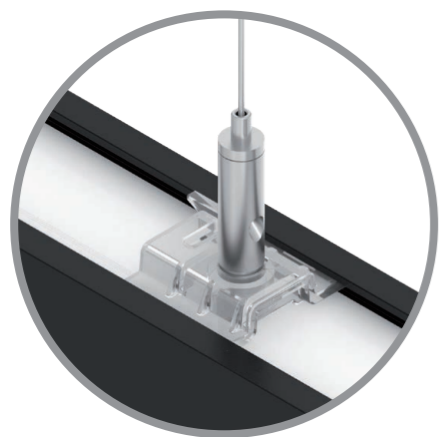

Mikropozycjoner – za jego pomocą możemy dowolnie regulować wysokość zawieszenia oprawy z dokładnością do 1 mm. Możliwość zmiany położenia mikropozycjonera.

Micropositioner - with it you can freely adjust the height of the luminaire suspension with an accuracy of 1 mm. It is possible to change the position of the micropositioner.

Mikropositionierer - mit ihm können Sie die Höhe der Leuchtaufhängung frei einstellen mit einer Genauigkeit von 1 mm. Möglichkeit, die Position des Mikropositionierers zu verändern.



Dyfuzor mikropryzmatyczny o strukturze heksagonalnej zapewniający ochronę antyślepieniową z wielu kierunków obserwacji.

Microprismatic diffuser with hexagonal structure providing anti-glare protection from multiple viewing directions.

Mikroprismenabdeckung mit sechseckiger Struktur für Blendschutz aus mehreren Blickrichtungen.

Snake Linear

modular system



Magnetic holder
Magnetic holder holding down the radiator and other accessories together

LED module
LED module on an aluminum base designed specifically by ILUM.

Reflector
White reflector made of high reflective PC profile to increase the efficiency of the luminaire.

Dark microcrystal diffuser
Dark microcrystal diffuser with hexagonal structure providing anti-glare protection from multiple viewing directions.



Wysłony - łączenie profili w sposób eliminujący świecenie przez szczeliny.

Black screens - connection of profiles in a way eliminating lighting gaps.

Blenden - Profile so verbinden, dass kein Licht durch Lücken scheint.



Zapięcie mechaniczne pozwalające na beznarzędziowe łączenie modułów systemu.

Mechanical lock allowing to connect the system modules without any tools.

Mechanisches Verbindungselement, das eine werkzeuglose Verbindung von Systemmodulen ermöglicht.



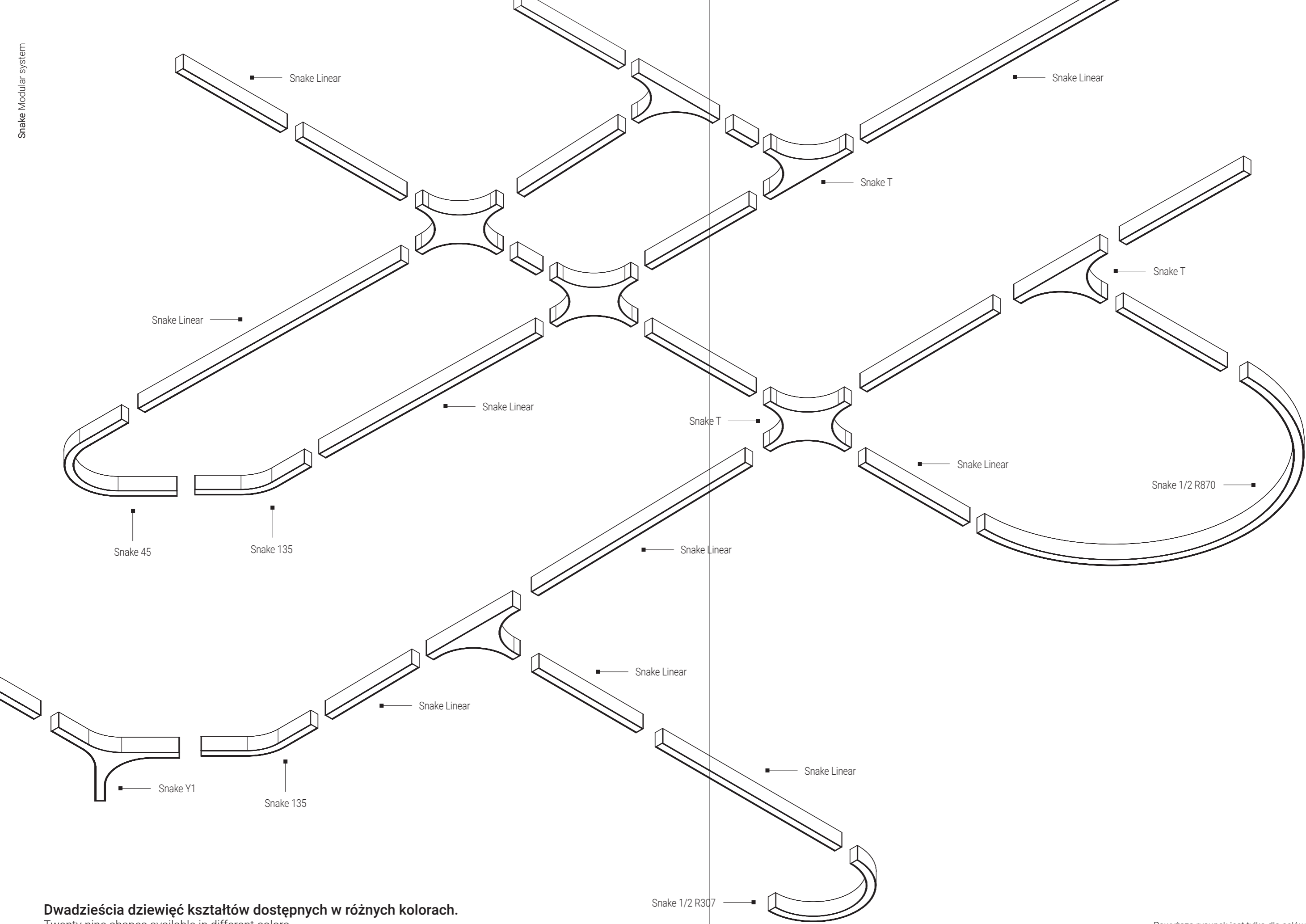

Dwadzieścia dziewięć kształtów dostępnych w różnych kolorach.

Twenty nine shapes available in different colors.
Neunundzwanzig Formen in verschiedenen Farben erhältlich.

Powyższa rysunek jest tylko dla celów poglądowych.
The figure above is for illustrative purposes only.
Die obige Abbildung dient nur zur Veranschaulichung



Snake Linear

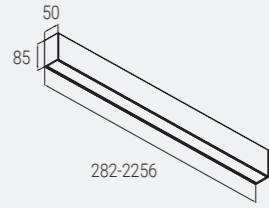
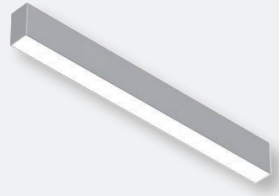

Snake 1/2
R 307



Snake 1/2
R 385



Snake 1/2
R 589

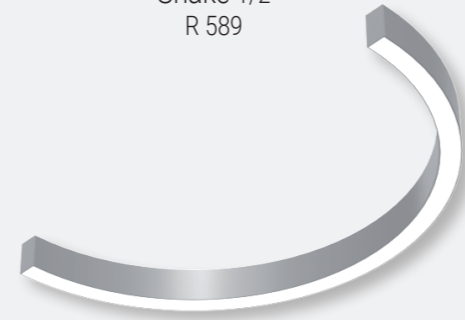

Snake 1/2
R 871

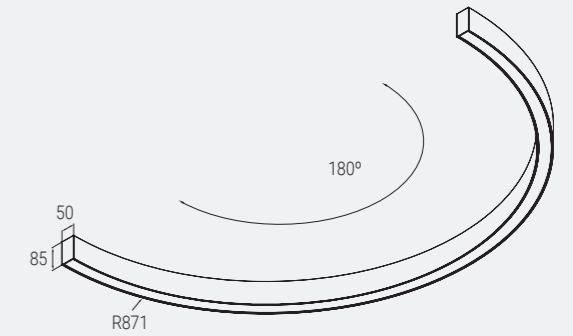
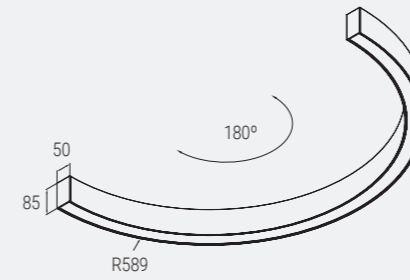
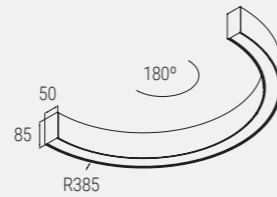
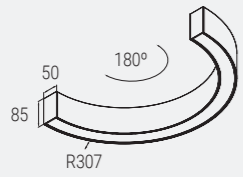

Snake 1/3
R 589



Snake 1/4
R 307



Snake 1/4
R 448



Snake 1/4
R 589

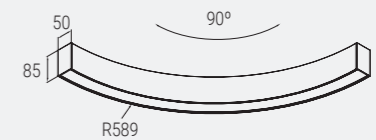
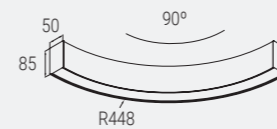
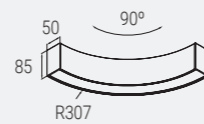
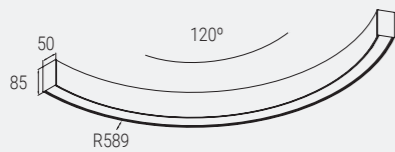

Dwadzieścia dziewięć kształtów
Twenty nine shapes
Neunundzwanzig Formen



Snake Linear

modular system

Snake 1/4
R 750

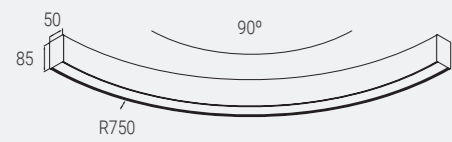

Snake 1/4
R 871

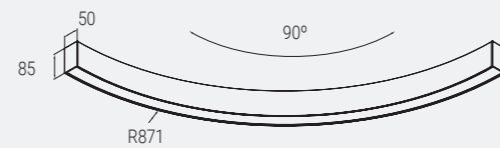

Snake 1/4
R 1153

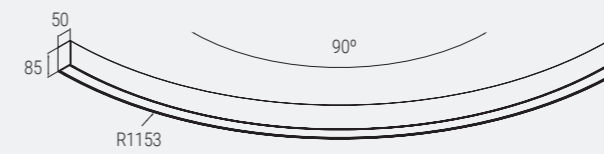

Snake 1/6
R 589

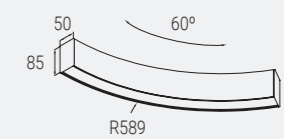

Snake 1/6
R 1500

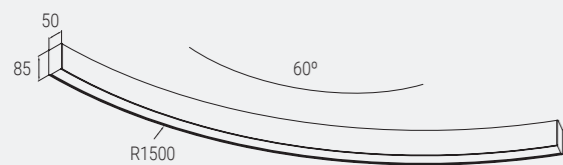

Snake 1/6
R 2050

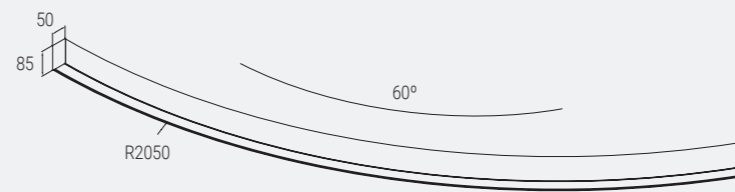

Snake 1/8
R 589

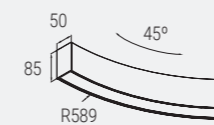

Snake 1/8
R 870

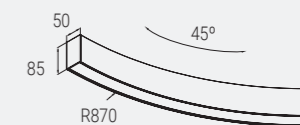

Dwadzieścia dziewięć kształtów
Twenty nine shapes
Neunundzwanzig Formen



Snake Linear

modular system

Snake 1/8
R 1153

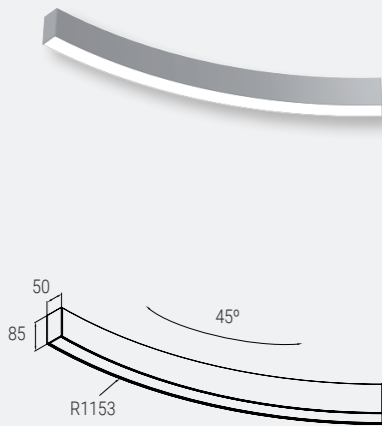

Snake 1/8
R 2550

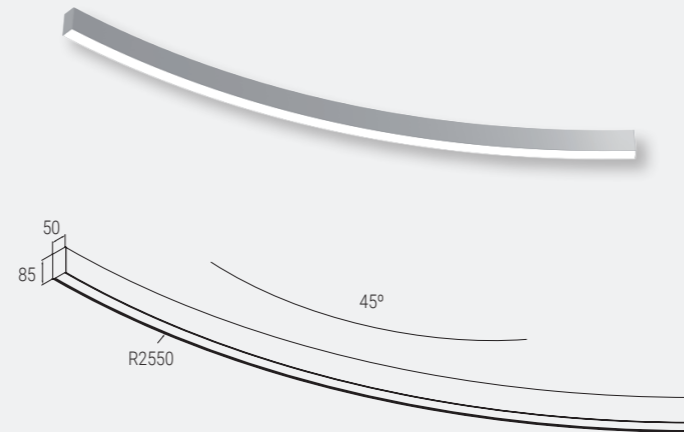

Snake 1/10
R 3000

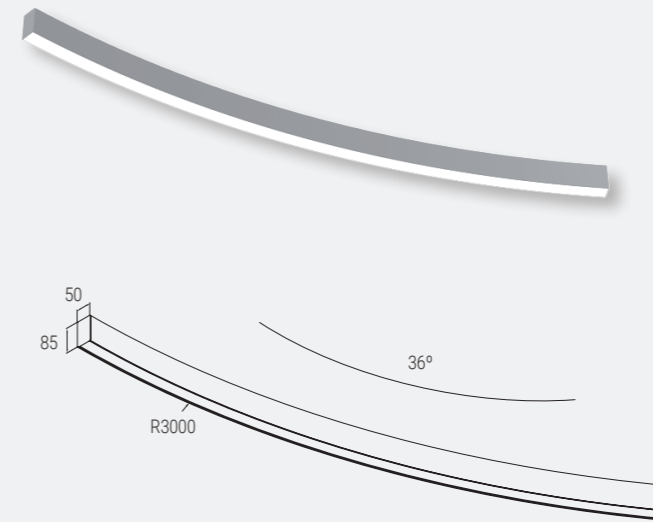

Snake 1/16
R 1153

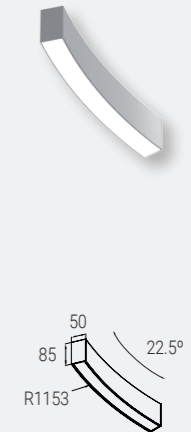

Snake 45

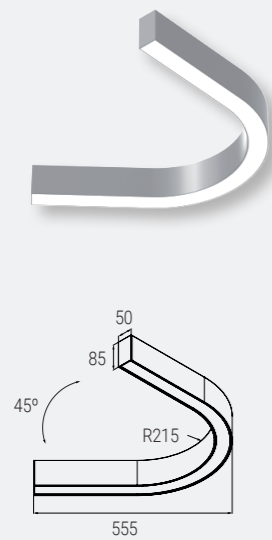

Snake 135

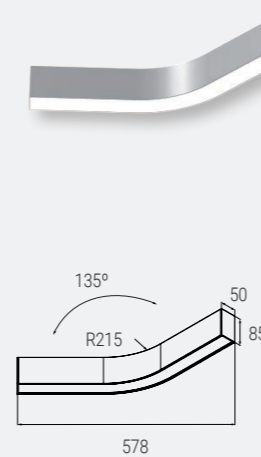

Snake T

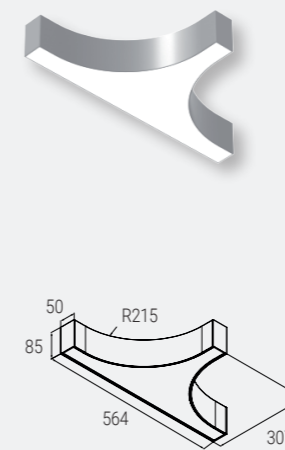

Snake X1

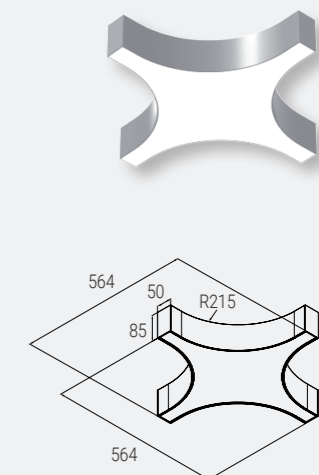

Dwadzieścia dziewięć kształtów
Twenty nine shapes
Neunundzwanzig Formen



Snake Linear

modular system

Snake X2

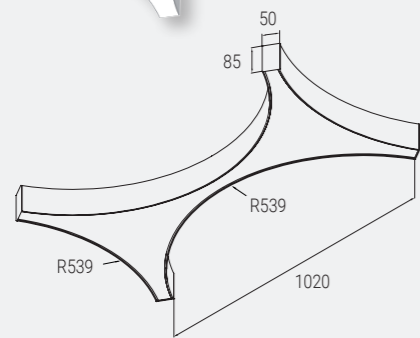

Snake Y1

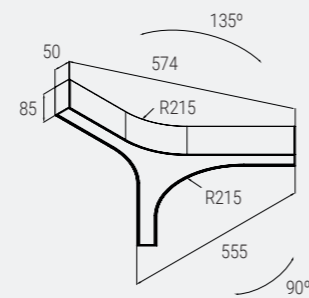
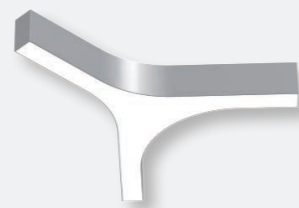

Snake Y2L

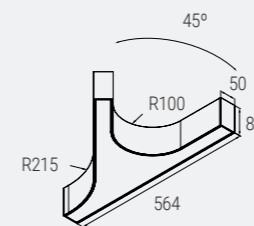

Snake Y2R

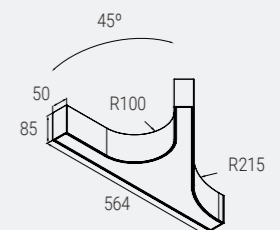
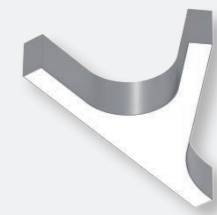

Snake Y3

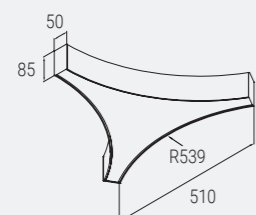

Dwadzieścia dziewięć kształtów
Twenty nine shapes
Neunundzwanzig Formen



Snake BB-Chili

modular system

Snake MI

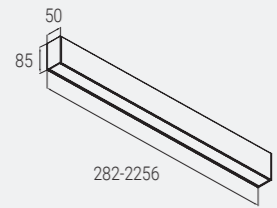
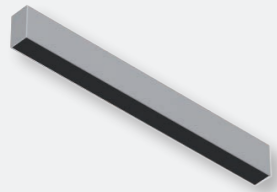

Snake BB-Chilli

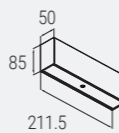

Snake BB - Dart

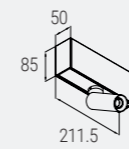

Snake 1/2 R 307

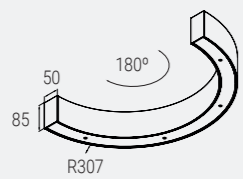
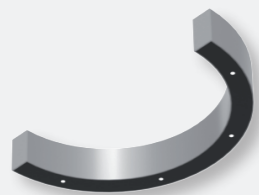

Snake 1/2 R 385

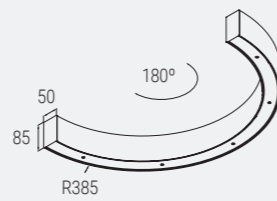
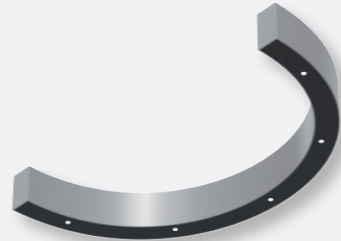

Snake 1/2 R 589

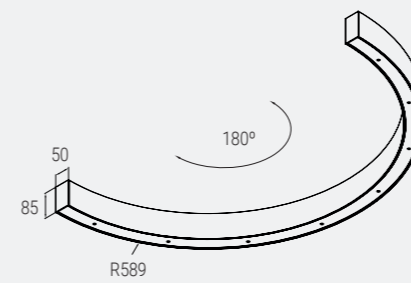

Snake 1/2 R 871

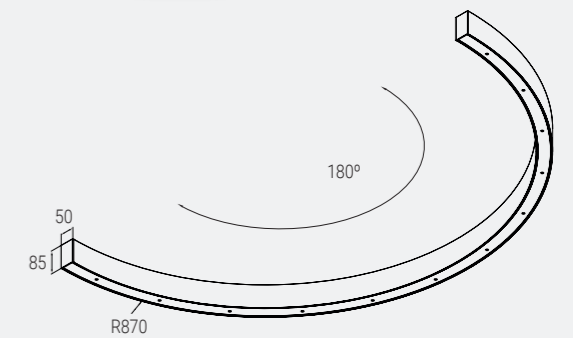
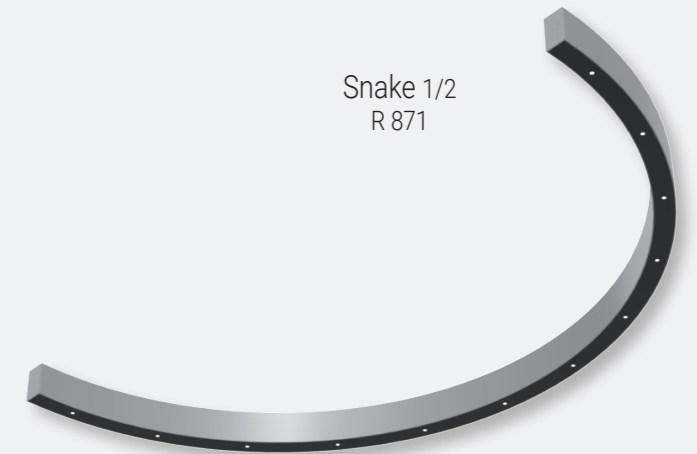

Dwadzieścia dziewięć kształtów
Twenty nine shapes
Neunundzwanzig Formen



Snake BB-Chili

modular system

Snake 1/3
R 589

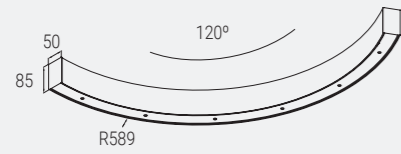

Snake 1/4
R 307

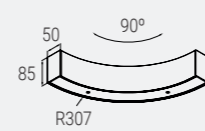

Snake 1/4
R 448

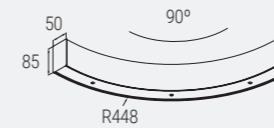

Snake 1/4
R 589



Snake 1/4
R 750

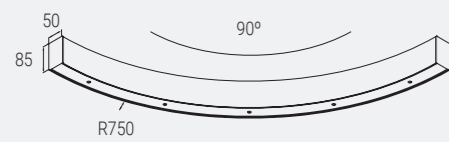

Snake 1/4
R 871

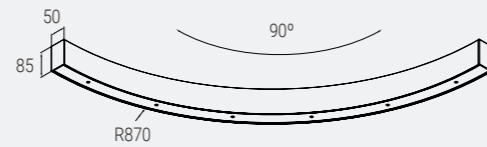

Snake 1/4
R 1153

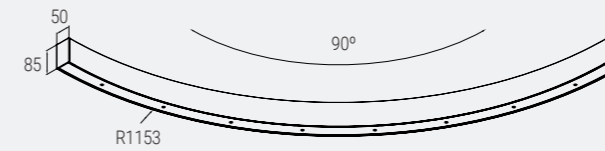

Snake 1/6
R 589

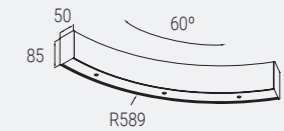

Dwadzieścia dziewięć kształtów
Twenty nine shapes
Neunundzwanzig Formen



Snake BB-Chili

modular system

Snake 1/6
R 1500

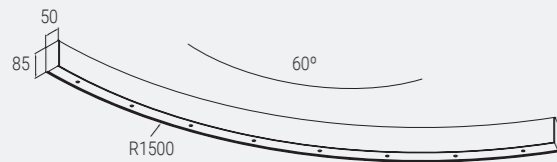

Snake 1/6
R 2050

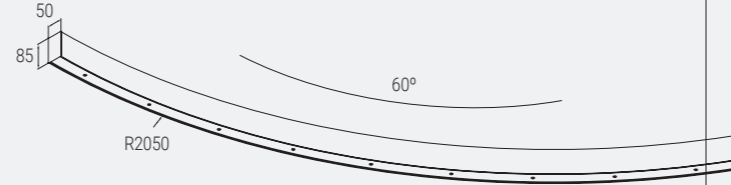
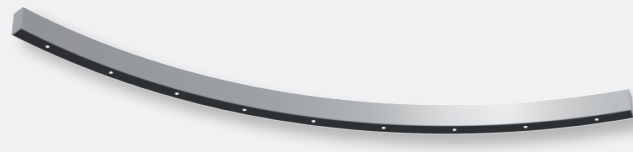

Snake 1/8
R 589

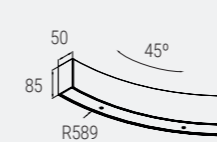

Snake 1/8
R 870

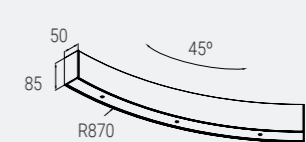
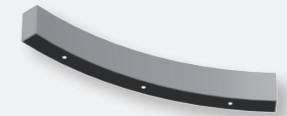

Snake 1/8
R 1153

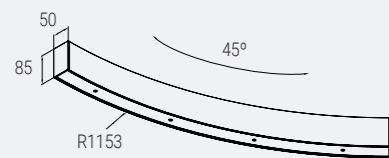
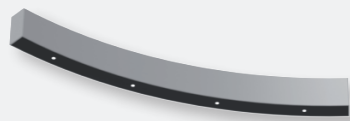

Snake 1/8
R 2550

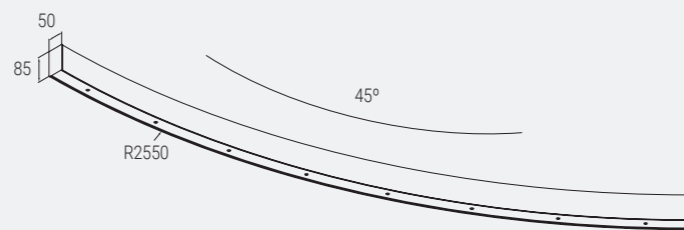
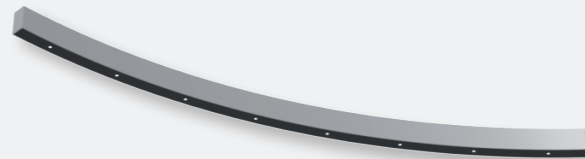

Snake 1/10
R 3000

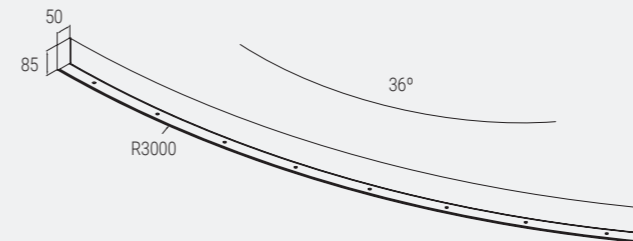
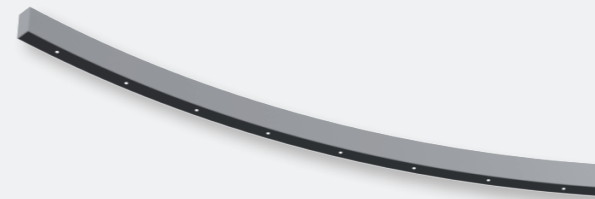

Snake 1/16
R 1153

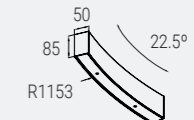

Dwadzieścia dziewięć kształtów
Twenty nine shapes
Neunundzwanzig Formen



Snake BB-Chili

modular system

Snake 45

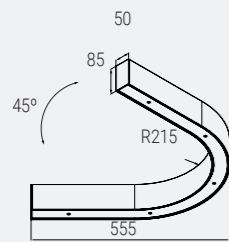

Snake 135

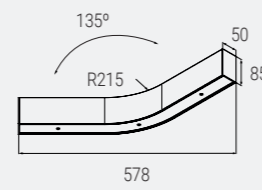

Snake T

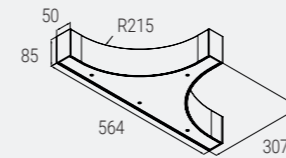
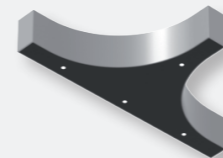

Snake X1

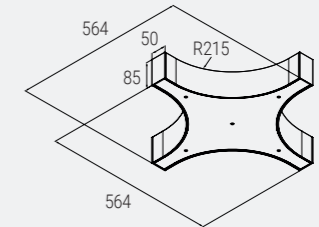

Snake X2

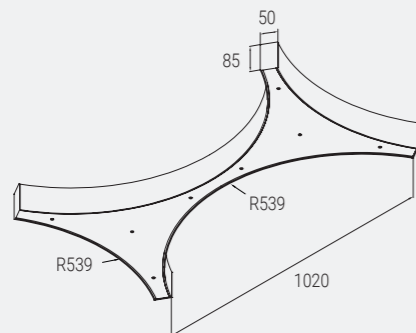
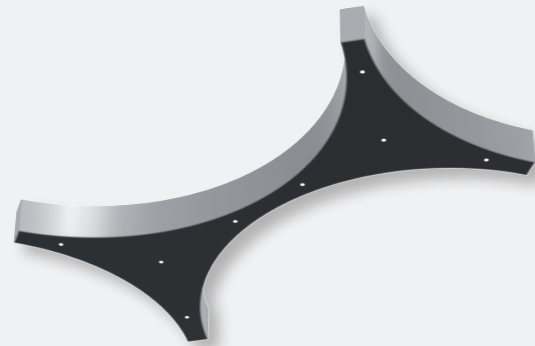

Snake Y1

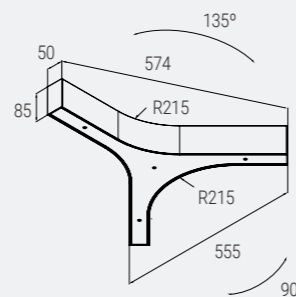
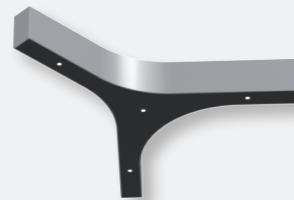

Snake Y2L

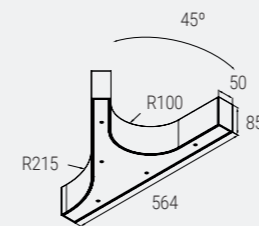

Snake Y2R

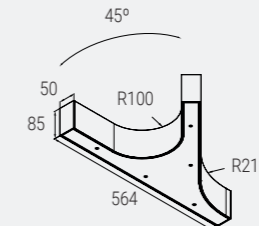
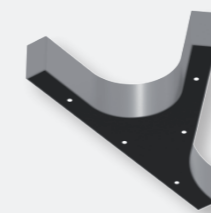

Snake Y3

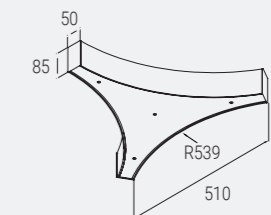

Dwadzieścia dziewięć kształtów
Twenty nine shapes
Neunundzwanzig Formen



Projektowanie jeszcze nie było tak proste!

Light Planner przekształca nawet najbardziej złożone projekty na łatwy język graficzny. Buduj konfiguracje, przeciągając przygotowane elementy z biblioteki. Wybierz długość, dodaj wybrane moduły, określ kolorystykę, ustaw ilość światła czy kąty rozsyłu.

Wycena zaprojektowanego systemu jest tworzona automatycznie, a zamówienie wysyłane jest jednym kliknięciem. Light Planner umożliwia eksportowanie rysunków do plików Autocad i profesjonalnych programów do projektowania oświetlenia. Umożliwia także tworzenie własnej biblioteki projektów.

Designing has never been so easy!

Light Planner converts even the most complex projects into easy graphic language. Build configurations by dragging prepared elements from the library. Choose the length, complement it with selected modules, determine the colors, set the amount of light or distribution angles.

The valuation of the designed system is created automatically and the order is sent with one click. Light Planner allows you to export your drawing to Autocad files and professional light design programs. It also allows you to create your own design library.

Entwerfen war noch nie so einfach!

Light Planner übersetzt selbst die komplexesten Angebote in eine einfache grafische Sprache. Erstellen Sie Konfigurationen, indem Sie vorbereitete Elemente aus der Bibliothek ziehen. Wählen Sie die Länge, ergänzen Sie sie mit ausgewählten Modulen, bestimmen Sie die Farben, stellen Sie die Lichtmenge oder die Verteilungswinkel ein.

Die Bewertung des entworfenen Systems wird automatisch erstellt und der Auftrag mit einem Klick versandt. Mit dem Light Planner können Sie Ihre Zeichnung in Autocad-Dateien und professionelle Lichtdesign-Programme exportieren. Es ermöglicht Ihnen auch, Ihre eigene Designbibliothek zu erstellen.

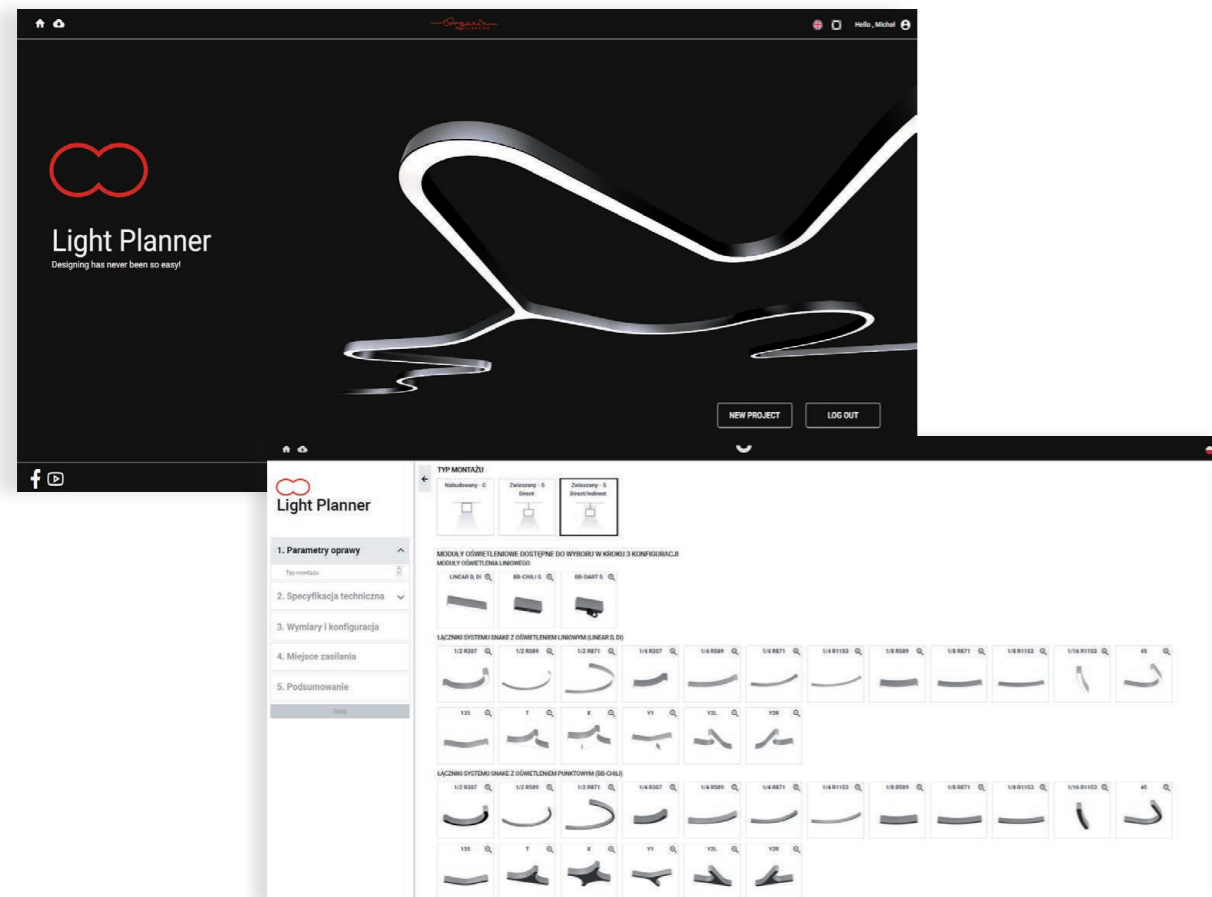

Light Planner

Configurator Snake system



www.lightplanner.eu





ORGANIC LIGHTING

ul. 1 Maja 46a
05-555 Tarczyn, Poland
tel: +48 22 736 73 00
info@organiclighting.eu



