

Rink

Round | Square



Our mission is healthy light.

We create human and environment – friendly solutions: natural, comfortable to the eye, rendering genuine colours. We believe in timeless and universal aesthetics. We design lamps that are minimalist in their form, and which can complement both traditional and modern architecture. To draw up custom designs, we approach each interior from a fresh perspective.

Quality is at the core of our work. All of our products are manufactured in our own factory in Tarczyn, with the help of a team of lighting experts – technology and product engineers. For 20 years, we have completed a plethora of projects, and each of them represents how we understand the culture of light and the way light can be experienced in space. When considering the role of light in contemporary architecture, one cannot disregard the history of Bauhaus. The school, or rather a free, creative collective of architects, artists and artisans, is celebrating its centenary year.

Light was of the building blocks of architecture in Modernism. In those times, as a result of technological progress electric light became just as important building material as concrete or steel. Shaping the experience of space through artificial light in buildings was an entirely new challenge for Bauhaus architects and designers. Their avant-garde approach to materials and forms, combined with the consolidation of modernist standards in terms of aesthetics and form in the middle of the 20th century, became the foundation for contemporary design.

Today, when looking at Infinite numbers of light fixtures and lamps, it is easy to forget that today's lighting culture has its roots in the school of Bauhaus and owe sit its shape.



Rink

Round C, S, P, F

Rink Round
S 560

Minimalistyczne wzornictwo

Seria "Rink" przekonuje minimalistycznym wzornictwem, nowoczesną technologią LED i szczególnie łatwym montażem. Korpus jest magnetycznie połączony z podstawą. Różnorodne kombinacje opraw Rink wpływają na możliwość zastosowania w niemal każdym pomieszczeniu. Szeroki wybór wzbogacają trzy dyfuzory, wiele rozmiarów i kolorów obudowy oraz cztery opcje montażu.

Minimalist design

The Rink series of luminaires convinces with its minimalist design, modern LED technology and an exceptionally easy installation. The body is magnetic connected to the base. The variety of combinations will be framed for the possibility of use in almost any place. The wide selection is enriched by three diffusers, many sizes and colors and four mounting options.

Minimalistisches Design

Die Leuchtenserie "Rink" überzeugt durch ihr minimalistisches Design, moderne LED-Technik und eine besonders einfache Installation. Der geschlossene Körper der Leuchte ist magnetisch mit dem Sockel verbunden, was die Installation vor Ort sehr einfach macht. Mit einer Auswahl von drei Abdeckungen, mehreren Gehäusegrößen und -farben und vier verschiedenen Montagemöglichkeiten bieten die Rink-Leuchten eine Vielzahl von Kombinationsmöglichkeiten für nahezu jede Anwendung.



Rink

Round / Square C, S, P, F

Rink Round C / Rink Square C
Nabudowany / Ceiling / Anbau

Rink Round S / Rink Square S
Zwieszany / Suspended / Abgependelt

Rink Round P / Rink Square P
Zwieszany / Suspended / Abgependelt

Rink Round F / Rink Square F
Wbudowany z ramką / Frame / Einbau mit Rahmen

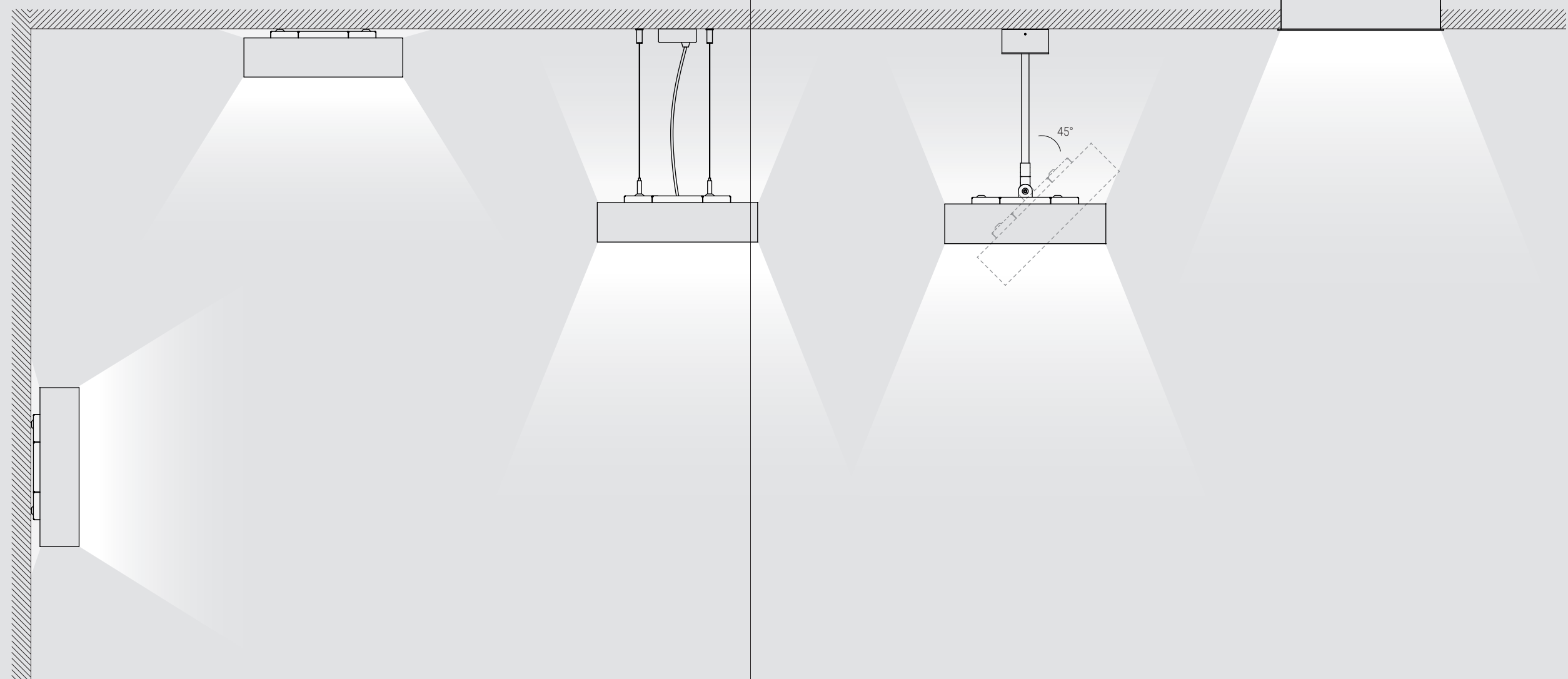

Rink Round C
Rink Square C
Nabudowany / Ceiling / Anbau

Doskonała wariantowość

Pięć rozmiarów opraw w kształcie okręgu zachwyca regularnością. Rozsyłane światło w kierunkach direct, direct-indirect przebija się miękko przez obudowę dostępną w czterech kolorach. Cztery sposoby montażu uzupełniają paletę wariantowości.

Perfection of variants

The five sizes of circle-shaped luminaires impress with their regularity. The distributed light in direct, direct-indirect directions penetrates softly through the housing available in four colors. Four mounting options complete the range of variants.

Perfekte Variabilität

Die fünf kreisförmigen Leuchten überzeugen durch ihre Regelmäßigkeit. Zur Auswahl stehen direktes oder direkt-indirektes Licht, das sanft durch ein in vier Farben erhältliches Gehäuse scheint. Vier Montagevarianten ergänzen die Palette der Variabilität.



A wide selection, many possibilities

Three different diffusers in one housing

Rink

Round / Square C, S, P, F

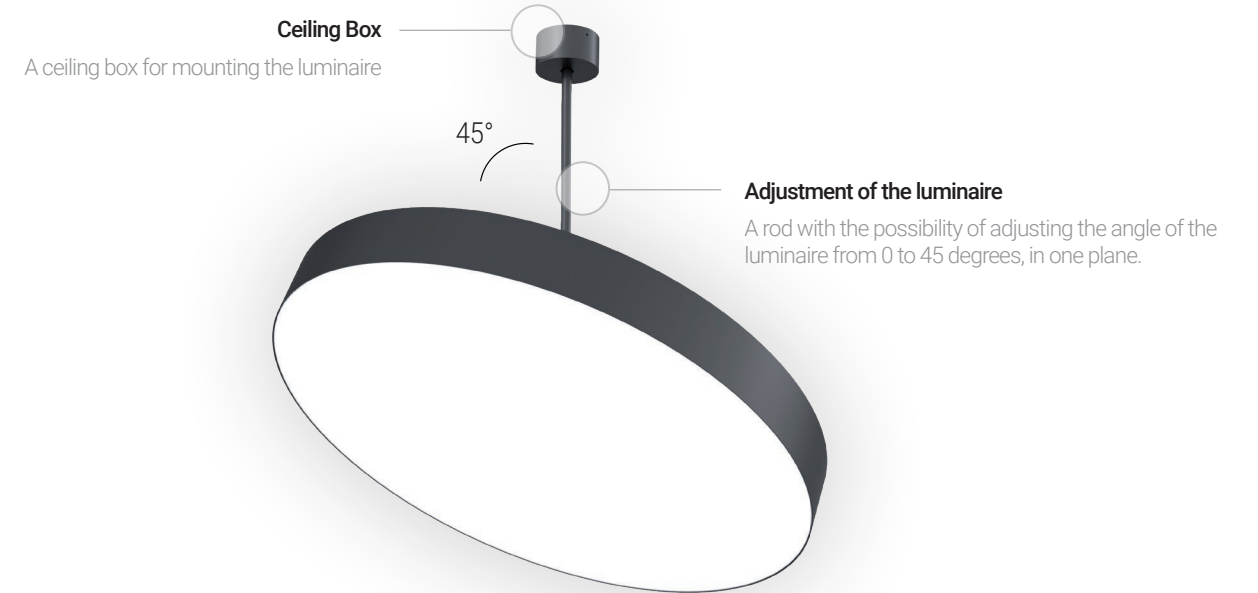

Miękkie, bezcieniowe światło

Wyjątkowy efekt świetlny możliwy do uzyskania dzięki zastosowaniu trzech rodzajów dyfuzora. Innowacyjne zamocowanie dostępne w czterech wariantach montażu pozwala na zastosowanie plafonów w pomieszczeniach ogólnego zastosowania jak biura, hotele, szkoły, itd.

Soft, shadowless light

The unique light effect possible to obtain thanks to the use of three types of diffuser. Innovative mounting available in four variants, allows the use of ceilings in general-purpose rooms such as offices, hotels, schools, etc.

Weiches, schattenfreies Licht

Einzigartiger Lichteffect erzielbar durch Verwendung von drei Arten Diffusoren. Innovative Befestigung - in vier Montagevarianten erhältlich - ermöglicht Verwendung von Rundleuchten in Mehrzweckräumen wie Büros, Hotels, Schulen, usw.



Rink

Round C, S, P, F

Rink Round C
Nabudowany / Ceiling / Anbau



Ø345 / Ø430 / Ø560 / Ø830 / Ø1110 mm

Rink Round P
Zwieszany / Suspended / Abgependelt



Ø345 / Ø430 / Ø560 / Ø830 / Ø1110 mm

Rink Round S
Zwieszany / Suspended / Abgependelt

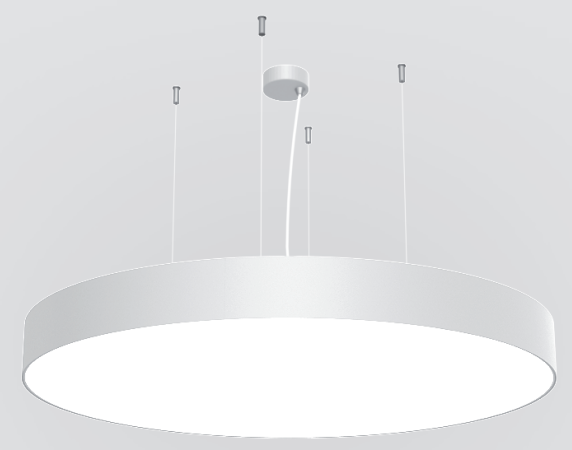

Ø345 / Ø430 / Ø560 / Ø830 / Ø1110 mm

Rink Round F
Wbudowany z ramką / Frame / Einbau mit Rahmen



Ø361 / Ø446 / Ø576 / Ø846 / Ø1126 mm

Four mounting variants available in four colors.
Five diameters tailored to your needs.





Rink

Round C

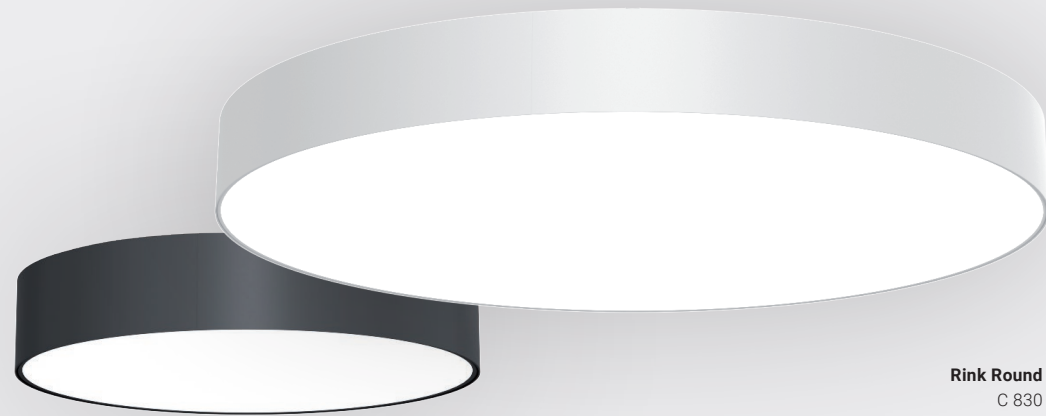

Rink Round
C 830

Rink Round
C 430

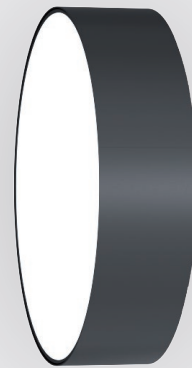

Rink Round
C 345

Cechy | Features | Eigenschaften

LED	3000K 4000K	CRI>80	SDCM ≤ 3	50000h L80 B10	IP20	ON/OFF DALI	220 - 240V 50-60HZ		
-----	----------------	--------	----------	-------------------	------	----------------	-----------------------	--	--

Colours:

PL

Montaż: nabudowany ściana/sufit .

Źródło światła: PCB LED, 3000K / 4000K, CRI> 80, MacAdam ≤ 3,50000h L80B10.

Moc oprawy: wersja high efficiency (HE), wersja high output (HO).

Dyfuzory: satyna, mikrokrystaliczny, ciemny mikrokrystaliczny.

Rozsył światła: bezpośredni, pośredni / pośredni.

Obudowa: wytłaczany profil aluminiowy malowany proszkowo.

Sterowanie: ON/OFF lub DALI.

Stopień ochrony: IP20

EN

Mounting: built-on wall / ceiling

Light source: PCB LED, 3000K / 4000K, CRI> 80, MacAdam ≤ 3,50000h L80B10.

Luminaire power: high efficiency (HE) version, high output (HO) version.

Diffusers: satin, microcrystal dark microcrystal.

Light distribution: direct, direct / indirect.

Housing: powder coated extruded aluminum profile.

Control: ON / OFF or DALI.

IP protection: IP20

DE

Installation: angebaut Wand/Decke.

Lichtquelle: PCB LED, 3000K / 4000K, CRI> 80, MacAdam ≤ 3,50000h L80B10.

Leuchtenleistung: hohe Effizienz (HE) Version, hohe Leistung (HO) Version.

Diffusor: satiniert, Microcrystale, dunkel Microcrystale.

Lichtverteilung: Direkt, Direkt/Indirekt.

Gehäuse: Aluminium-Strangpressprofil, pulverbeschichtet..

Steuerung: EIN-AUS oder DALI.

Schutzart : IP20

Rink Round C DIRECT



Type	Dimensions	Power	Luminaire flux *			Code
			satine	microcrystal	dark microcrystal UGR<19	
Version with LED CC HE (High Efficiency)	Rinks Round C Ø345 mm	7.9 W	1087 lm	1106 lm	676 lm	5.2101.01C1.fg6i.j0
	Rinks Round C Ø430 mm	15.3 W	2108 lm	2144 lm	1311 lm	5.2101.02C1.fg6i.j0
	Rinks Round C Ø560 mm	22.3 W	3081 lm	3133 lm	1915 lm	5.2101.03C1.fg6i.j0
	Rinks Round C Ø830 mm	47 W	6485 lm	6596 lm	4033 lm	5.2101.04C1.fg6i.j0
	Rinks Round C Ø1110 mm	87 W	11998 lm	12203 lm	7460 lm	5.2101.05C1.fg6i.j0

Version with LED CC HO (High Output)

Rinks Round C Ø345 mm	13.5 W	1776 lm	1807 lm	1105 lm	5.2101.01C1.fg7i.j0
Rinks Round C Ø430 mm	21 W	2759 lm	2806 lm	1715 lm	5.2101.02C1.fg7i.j0
Rinks Round C Ø560 mm	31.6 W	4152 lm	4223 lm	2581 lm	5.2101.03C1.fg7i.j0
Rinks Round C Ø830 mm	70.6 W	9265 lm	9424 lm	5761 lm	5.2101.04C1.fg7i.j0
Rinks Round C Ø1110 mm	134.1 W	17607 lm	17909 lm	10948 lm	5.2101.05C1.fg7i.j0

Rink Round C DIRECT/INDIRECT



Type	Dimensions	Power	Luminaire flux *			Code
			satine	microcrystal	dark microcrystal UGR<19	
Version with LED CC HE (High Efficiency)	Rinks Round C Ø345 mm	7.9 W	1065+22 lm	1084+22 lm	654+22 lm	5.2101.01B1.fg6i.j0
	Rinks Round C Ø430 mm	15.3 W	2066+42 lm	2102+42 lm	1269+42 lm	5.2101.02B1.fg6i.j0
	Rinks Round C Ø560 mm	22.3 W	3019+62 lm	3071+62 lm	1853+62 lm	5.2101.03B1.fg6i.j0
	Rinks Round C Ø830 mm	47 W	6354+131 lm	6465+131 lm	3902+131 lm	5.2101.04B1.fg6i.j0
	Rinks Round C Ø1110 mm	87 W	11757+241 lm	11962+241 lm	7219+241 lm	5.2101.05B1.fg6i.j0

Version with LED CC HO (High Output)

Rinks Round C Ø345 mm	13.5 W	1738+38 lm	1769+38 lm	1067+38 lm	5.2101.01B1.fg7i.j0
Rinks Round C Ø430 mm	21 W	2701+58 lm	2748+58 lm	1657+58 lm	5.2101.02B1.fg7i.j0
Rinks Round C Ø560 mm	31.6 W	4064+88 lm	4135+88 lm	2493+88 lm	5.2101.03B1.fg7i.j0
Rinks Round C Ø830 mm	70.6 W	9069+196 lm	9228+196 lm	5565+196 lm	5.2101.04B1.fg7i.j0
Rinks Round C Ø1110 mm	134.1 W	17235+372 lm	17537+372 lm	10576+372 lm	5.2101.05B1.fg7i.j0

Strumień świetlny oprawy podany dla 4000K.
Fixture lumen output data refer to 4000K.
Lichtstrom der Leuchte spezifiziert für 4000K.

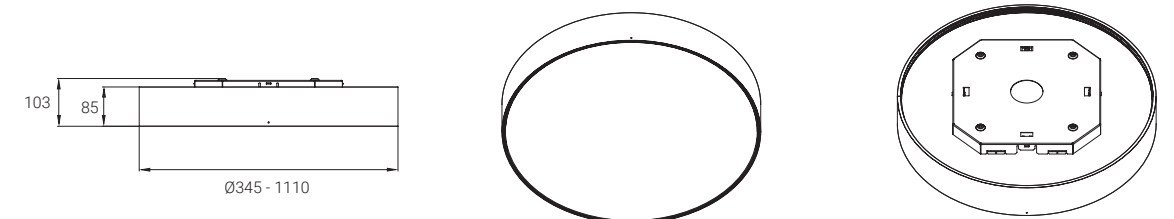

Driver	f	LED color	g	Diffuser	i	Finishing	j
ON/OFF	1	830	2	satine	1	white (RAL9016)	4
DALI	2	840	3	microcrystal	2	black (RAL9005)	5
				dark microcrystal	8	fog (RAL7038)	6
						graphite (RAL7024)	H



Rink

Round S



Rink Round
S 830

Rink Round
S 560

Cechy | Features | Eigenschaften

LED | 3000K / 4000K | CRI>80 | SDCM ≤ 3 | 50000h L80 B10 | IP20 | ON/OFF DALI | 220 - 240V 50-60HZ |  | 

Colours:    

PL

Montaż: zwieszany

Źródło światła: PCB LED, 3000K / 4000K, CRI> 80, MacAdam ≤ 3,50000h L80B10.

Moc oprawy: wersja high efficiency (HE), wersja high output (HO).

Dyfuzory: satyna, mikrokrystaliczny, ciemny mikrokrystaliczny.

Rozsył światła: bezpośredni, pośredni / pośredni.

Obudowa: wytłaczany profil aluminiowy malowany proszkowo.

Sterowanie: ON/OFF lub DALI.

Stopień ochrony: IP20

EN

Mounting: suspended

Light source: PCB LED, 3000K / 4000K, CRI> 80, MacAdam ≤ 3,50000h L80B10.

Luminaire power: high efficiency (HE) version, high output (HO) version.

Diffusers: satin, microcrystal dark microcrystal.

Light distribution: direct, direct / indirect.

Housing: powder coated extruded aluminum profile.

Control: ON / OFF or DALI.

IP protection: IP20

DE

Installation: abgependelt

Lichtquelle: PCB LED, 3000K / 4000K, CRI> 80, MacAdam ≤ 3,50000h L80B10.

Leuchtenleistung: hohe Effizienz (HE) Version, hohe Leistung (HO) Version.

Diffusor: satiniert, Microcrystale, dunkel Microcrystale.

Lichtverteilung: Direkt, Direkt/Indirekt.

Gehäuse: Aluminium-Strangpressprofil, pulverbeschichtet.

Steuerung: EIN-AUS oder DALI.

Schutzart: IP20

Rink Round S DIRECT



Version with
LED CC HE
(High Efficiency)

Version with
LED CC HO
(High Output)

Type	Dimensions	Power	Luminaire flux *			Code
			satine	microcrystal	dark microcrystal UGR<19	
Rinks Round S	Ø345 mm	7.9 W	1087 lm	1106 lm	676 lm	5.2102.01D1.fg6i.j0
Rinks Round S	Ø430 mm	15.3 W	2108 lm	2144 lm	1311 lm	5.2102.02D1.fg6i.j0
Rinks Round S	Ø560 mm	22.3 W	3081 lm	3133 lm	1915 lm	5.2102.03D1.fg6i.j0
Rinks Round S	Ø830 mm	47 W	6485 lm	6596 lm	4033 lm	5.2102.04D1.fg6i.j0
Rinks Round S	Ø1110 mm	87 W	11998 lm	12203 lm	7460 lm	5.2102.05D1.fg6i.j0

Rink Round S DIRECT/INDIRECT



Version with
LED CC HE
(High Efficiency)

Version with
LED CC HO
(High Output)

Type	Dimensions	Power	Luminaire flux *			Code
			satine	microcrystal	dark microcrystal UGR<19	
Rinks Round S	Ø345 mm	7.9+4.3 W	1087+619 lm	1106+619 lm	676+619 lm	5.2102.01I1.fg6i.j0
Rinks Round S	Ø430 mm	15.3+7.5 W	2108+1081 lm	2144+1081 lm	1311+1081 lm	5.2102.02I1.fg6i.j0
Rinks Round S	Ø560 mm	22.3+10.8 W	3081+1544 lm	3133+1544 lm	1915+1544 lm	5.2102.03I1.fg6i.j0
Rinks Round S	Ø830 mm	47+21.5 W	6485+3089 lm	6596+3089 lm	4033+3089 lm	5.2102.04I1.fg6i.j0
Rinks Round S	Ø1110 mm	87+38.8 W	11998+5563 lm	12203+5563 lm	7460+5563 lm	5.2102.05I1.fg6i.j0

Strumień świetlny oprawy podany dla 4000K.
Fixture lumen output data refer to 4000K.
Lichtstrom der Leuchte spezifiziert für 4000K.

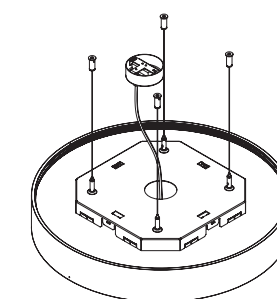
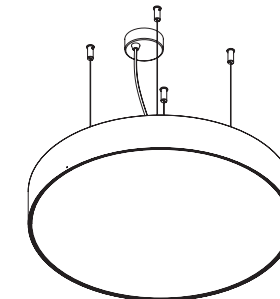
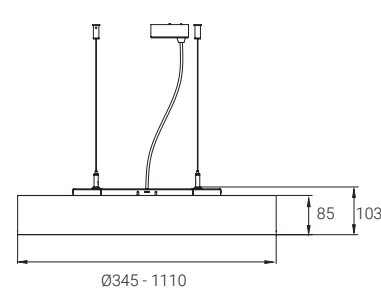

Driver	f	LED color	g	Diffuser	i	Finishing	j
ON/OFF	1	830	2	satine	1	white (RAL9016)	4
DALI	2	840	3	microcrystal	2	black (RAL9005)	5
				dark microcrystal	8	fog (RAL7038)	6
						graphite (RAL7024)	H



Rink

Round P



Rink Round
P 830



Rink Round
P 345

Cechy | Features | Eigenschaften

LED	3000K 4000K	CRI>80	SDCM ≤ 3	50000h L80 B10	IP20	ON/OFF DALI	220 - 240V 50-60HZ		
-----	----------------	--------	----------	-------------------	------	----------------	-----------------------	--	--

Colours:

PL

Montaż: zwieszany na sztywnym regulowanym uchwycie.

Źródło światła: PCB LED, 3000K / 4000K, CRI> 80, MacAdam ≤ 3,50000h L80B10.

Moc oprawy: wersja high efficiency (HE), wersja high output (HO).

Dyfuzory: satyna, mikrokrystaliczny, ciemny mikrokrystaliczny.

Rozsył światła: bezpośredni, pośredni / pośredni.

Obudowa: wytłaczany profil aluminiowy malowany proszkowo.

Sterowanie: ON/OFF lub DALI.

Stopień ochrony: IP20

EN

Mounting: suspended on rigid adjustable rod

Light source: PCB LED, 3000K / 4000K, CRI> 80, MacAdam ≤ 3,50000h L80B10.

Luminaire power: high efficiency (HE) version, high output (HO) version.

Diffusers: satin, microcrystal dark microcrystal.

Light distribution: direct, direct / indirect.

Housing: powder coated extruded aluminum profile.

Control: ON / OFF or DALI.

IP protection: IP20

DE

Installation: abgependelt montiert auf einer festen, verstellbaren Halterung.

Lichtquelle: PCB LED, 3000K / 4000K, CRI> 80, MacAdam ≤ 3,50000h L80B10.

Leuchtenleistung: hohe Effizienz (HE) Version, hohe Leistung (HO) Version.

Diffusor: satiniert, Microcrystale, dunkel Microcrystale.

Lichtverteilung: Direkt, Direkt/Indirekt.

Gehäuse: Aluminium-Strangpressprofil, pulverbeschichtet.

Steuerung: EIN-AUS oder DALI.

Schutzart: IP20

Rink Round P DIRECT



Version with
LED CC HE
(High Efficiency)

Type	Dimensions	Power	Luminaire flux *			Code
			satine	microcrystal	dark microcrystal UGR<19	
Rinks Round P	Ø345 mm	7.9 W	1087 lm	1106 lm	676 lm	5.2105.01D1.fg6i.j0
Rinks Round P	Ø430 mm	15.3 W	2108 lm	2144 lm	1311 lm	5.2105.02D1.fg6i.j0
Rinks Round P	Ø560 mm	22.3 W	3081 lm	3133 lm	1915 lm	5.2105.03D1.fg6i.j0
Rinks Round P	Ø830 mm	47 W	6485 lm	6596 lm	4033 lm	5.2105.04D1.fg6i.j0
Rinks Round P	Ø1110 mm	87 W	11998 lm	12203 lm	7460 lm	5.2105.05D1.fg6i.j0

Version with
LED CC HO
(High Output)

Rinks Round P	Ø345 mm	13.5 W	1776 lm	1807 lm	1105 lm	5.2105.01D1.fg7i.j0
Rinks Round P	Ø430 mm	21 W	2759 lm	2806 lm	1715 lm	5.2105.02D1.fg7i.j0
Rinks Round P	Ø560 mm	31.6 W	4152 lm	4223 lm	2581 lm	5.2105.03D1.fg7i.j0
Rinks Round P	Ø830 mm	70.6 W	9265 lm	9424 lm	5761 lm	5.2105.04D1.fg7i.j0
Rinks Round P	Ø1110 mm	134.1 W	17607 lm	17909 lm	10948 lm	5.2105.05D1.fg7i.j0

Rink Round P DIRECT/INDIRECT



Version with
LED CC HE
(High Efficiency)

Type	Dimensions	Power	Luminaire flux *			Code
			satine	microcrystal	dark microcrystal UGR<19	
Rinks Round P	Ø345 mm	7.9+4.3 W	1087+619 lm	1106+619 lm	676+619 lm	5.2105.01I1.fg6i.j0
Rinks Round P	Ø430 mm	15.3+7.5 W	2108+1081 lm	2144+1081 lm	1311+1081 lm	5.2105.02I1.fg6i.j0
Rinks Round P	Ø560 mm	22.3+10.8 W	3081+1544 lm	3133+1544 lm	1915+1544 lm	5.2105.03I1.fg6i.j0
Rinks Round P	Ø830 mm	47+21.5 W	6485+3089 lm	6596+3089 lm	4033+3089 lm	5.2105.04I1.fg6i.j0
Rinks Round P	Ø1110 mm	87+38.8 W	11998+5563 lm	12203+5563 lm	7460+5563 lm	5.2105.05I1.fg6i.j0

Version with
LED CC HO
(High Output)

Rinks Round P	Ø345 mm	13.5+4.3 W	1776+619 lm	1807+619 lm	1105+619 lm	5.2105.01I1.fg7i.j0
Rinks Round P	Ø430 mm	21+7.5 W	2759+1081 lm	2806+1081 lm	1715+1081 lm	5.2105.02I1.fg7i.j0
Rinks Round P	Ø560 mm	31.6+10.8 W	4152+1544 lm	4223+1544 lm	2581+1544 lm	5.2105.03I1.fg7i.j0
Rinks Round P	Ø830 mm	70.6+21.5 W	9265+3089 lm	9424+3089 lm	5761+3089 lm	5.2105.04I1.fg7i.j0
Rinks Round P	Ø1110 mm	134.1+38.8 W	17607+5563 lm	17909+5563 lm	10948+5563 lm	5.2105.05I1.fg7i.j0

Strumień świetlny oprawy podany dla 4000K.
Fixture lumen output data refer to 4000K.
Lichtstrom der Leuchte spezifiziert für 4000K.

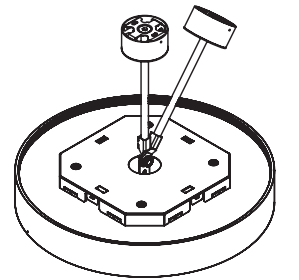
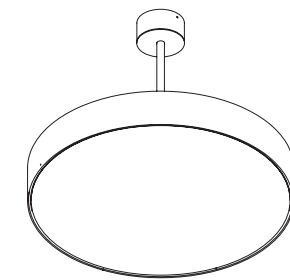
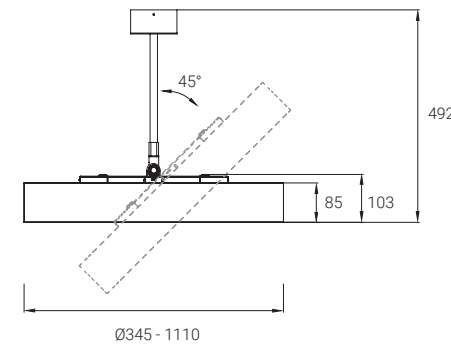

Driver	f	LED color	g	Diffuser	i	Finishing	j
ON/OFF	1	830	2	satine	1	white (RAL9016)	4
DALI	2	840	3	microcrystal	2	black (RAL9005)	5
				dark microcrystal	8	fog (RAL7038)	6
						graphite (RAL7024)	H





Rink

Round F

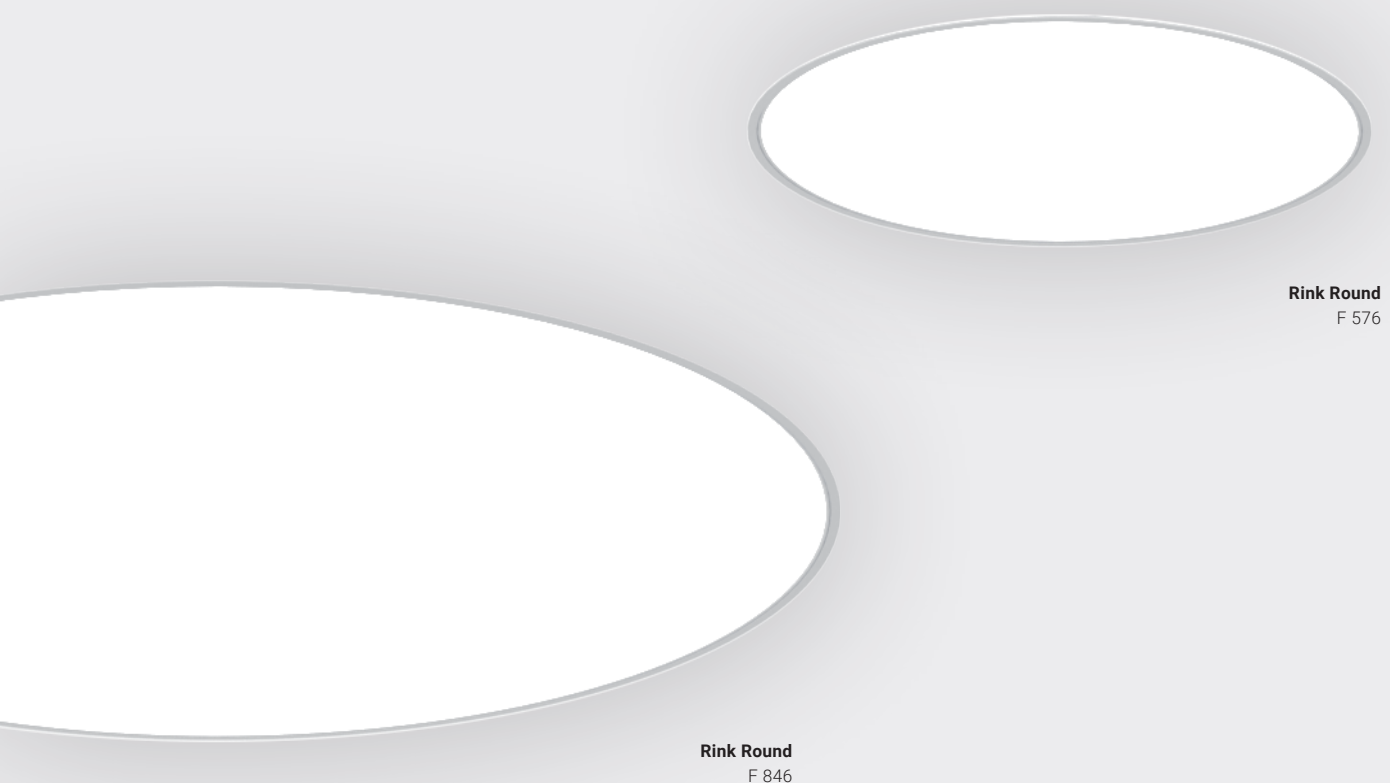

Cechy | Features | Eigenschaften

LED	3000K 4000K	CRI>80	SDCM ≤ 3	50000h L80 B10	IP20	ON/OFF DALI	220 - 240V 50-60HZ		
-----	----------------	--------	----------	-------------------	------	----------------	-----------------------	--	--

Colours:

PL

Montaż: wbudowany z ramką.

Źródło światła: PCB LED, 3000K / 4000K, CRI> 80, MacAdam ≤ 3,50000h L80B10.

Moc oprawy: wersja high efficiency (HE), wersja high output (HO).

Dyfuzory: satyna, mikrokrystaliczny, ciemny mikrokrystaliczny.

Rozsył światła: bezpośredni

Obudowa: wytłaczany profil aluminiowy malowany proszkowo.

Sterowanie: ON/OFF lub DALI.

Stopień ochrony: IP20

EN

Mounting: recessed with a frame.

Light source: PCB LED, 3000K / 4000K, CRI> 80, MacAdam ≤ 3,50000h L80B10.

Luminaire power: high efficiency (HE) version, high output (HO) version.

Diffusers: satin, microcrystal dark microcrystal.

Light distribution: direct

Housing: powder coated extruded aluminum profile.

Control: ON / OFF or DALI.

IP protection: IP20

DE

Installation: Eingebaut mit Rahmen.

Lichtquelle: PCB LED, 3000K / 4000K, CRI> 80, MacAdam ≤ 3,50000h L80B10.

Leuchtenleistung: hohe Effizienz (HE) Version, hohe Leistung (HO) Version.

Diffuser: satiniert, Microcrystale, dunkel Microcrystale.

Lichtverteilung: Direkt.

Gehäuse: Aluminium-Strangpressprofil, pulverbeschichtet..

Steuerung: EIN-AUS oder DALI.

Schutzart: IP20

Rink Round F DIRECT



Type	Dimensions	Power	Luminaire flux *			Code
			satine	microcrystal	dark microcrystal UGR<19	
Version with LED CC HE (High Efficiency)	Rinks Round F Ø361 mm	7.9 W	1087 lm	1106 lm	676 lm	5.2103.01F1.fg6ij0
	Rinks Round F Ø446 mm	15.3 W	2108 lm	2144 lm	1311 lm	5.2103.02F1.fg6ij0
	Rinks Round F Ø576 mm	22.3 W	3081 lm	3133 lm	1915 lm	5.2103.03F1.fg6ij0
	Rinks Round F Ø846 mm	47 W	6485 lm	6596 lm	4033 lm	5.2103.04F1.fg6ij0
Rinks Round F Ø1126 mm	87 W	11998 lm	12203 lm	7460 lm	5.2103.05F1.fg6ij0	
Version with LED CC HO (High Output)	Rinks Round F Ø361 mm	13.5 W	1776 lm	1807 lm	1105 lm	5.2103.01F1.fg7ij0
	Rinks Round F Ø446 mm	21 W	2759 lm	2806 lm	1715 lm	5.2103.02F1.fg7ij0
	Rinks Round F Ø576 mm	31.6 W	4152 lm	4223 lm	2581 lm	5.2103.03F1.fg7ij0
	Rinks Round F Ø846 mm	70.6 W	9265 lm	9424 lm	5761 lm	5.2103.04F1.fg7ij0
	Rinks Round F Ø1126 mm	134.1 W	17607 lm	17909 lm	10948 lm	5.2103.05F1.fg7ij0

Ø - 10 mm | Hmin = 130 mm

Strumień świetlny oprawy podany dla 4000K.
Fixture lumen output data refer to 4000K.
Lichtstrom der Leuchte spezifiziert für 4000K.

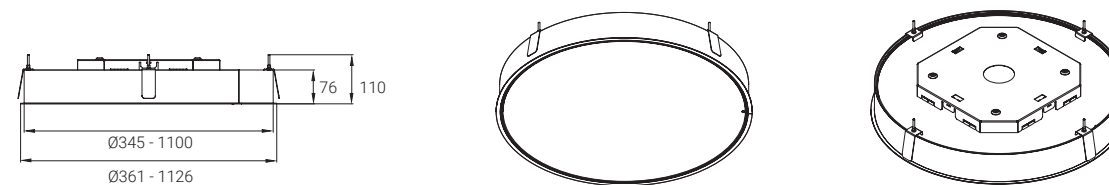
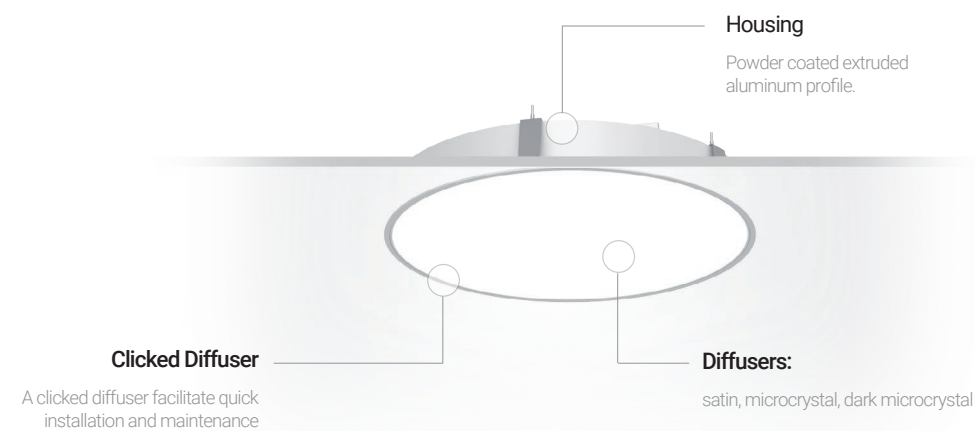

Driver	f	LED color	g	Diffuser	i	Finishing	j
ON/OFF	1	830	2	satine	1	white (RAL9016)	4
DALI	2	840	3	microcrystal	2	black (RAL9005)	5
				dark microcrystal	8	fog (RAL7038)	6
						graphite (RAL7024)	H







Rink Square C, S, P, F

Rink

Square C, S, P, F

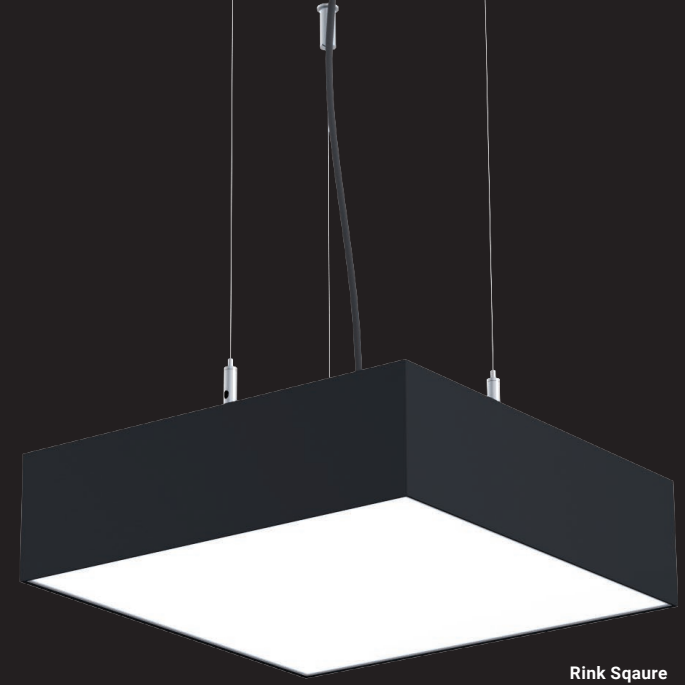

Rink Square
S 430 x 430

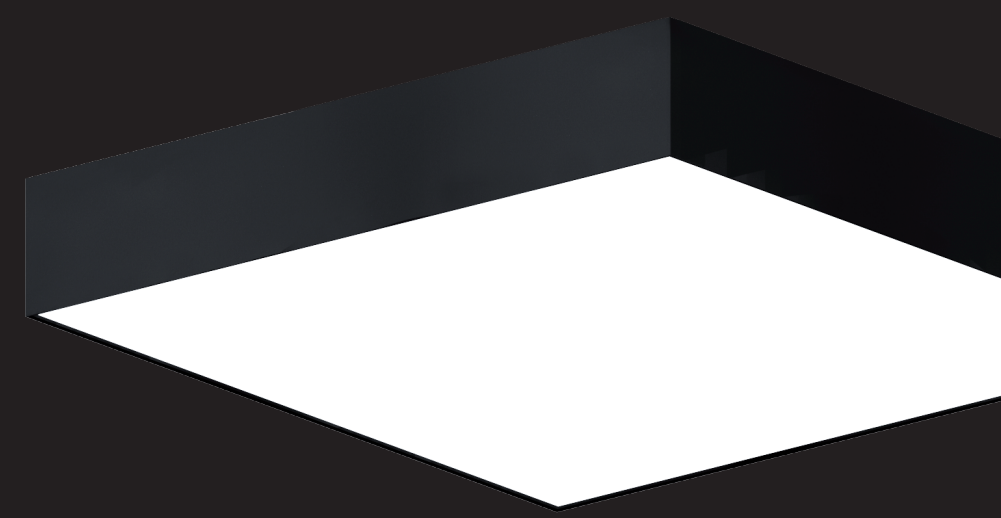

Rink Square
C 560 x 560

Minimalistyczne wzornictwo

Seria "Rink" przekonuje minimalistycznym wzornictwem, nowoczesną technologią LED i szczególnie łatwym montażem. Korpus jest magnetycznie połączony z podstawą. Różnorodne kombinacje opraw Rink wpływają na możliwość zastosowania w niemal każdym pomieszczeniu. Szeroki wybór wzbogacają trzy dyfuzory, wiele rozmiarów i kolorów obudowy oraz cztery opcje montażu.

Minimalist design

The Rink series of luminaires convinces with its minimalist design, modern LED technology and an exceptionally easy installation. The body is magnetic connected to the base. The variety of combinations will be framed for the possibility of use in almost any place. The wide selection is enriched by three diffusers, many sizes and colors and four mounting options.

Minimalistisches Design

Die Leuchtenserie "Rink" überzeugt durch ihr minimalistisches Design, moderne LED-Technik und eine besonders einfache Installation. Der geschlossene Körper der Leuchte ist magnetisch mit dem Sockel verbunden, was die Installation vor Ort sehr einfach macht. Mit einer Auswahl von drei Abdeckungen, mehreren Gehäusegrößen und -farben und vier verschiedenen Montagemöglichkeiten bieten die Rink-Leuchten eine Vielzahl von Kombinationsmöglichkeiten für nahezu jede Anwendung.



Rink

Square C, S, P, F

Rink Square C

Nabudowany / Ceiling / Anbau

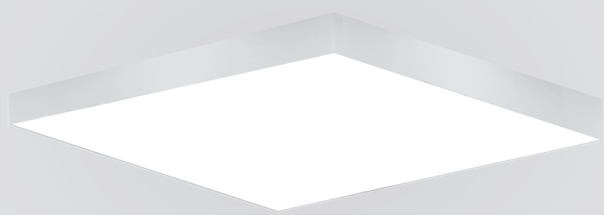

300 x 300 | 430 x 430
560 x 560 | 830 x 830 | 1110 x 1110 mm

Rink Square P

Zwieszany / Suspended / Abgependelt



300 x 300 | 430 x 430
560 x 560 | 830 x 830 | 1110 x 1110 mm

Rink Square S

Zwieszany / Suspended / Abgependelt

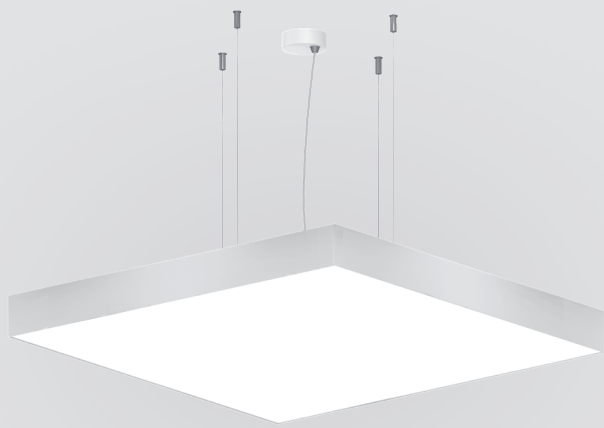

300 x 300 | 430 x 430
560 x 560 | 830 x 830 | 1110 x 1110 mm

Rink Square F

Wbudowany z ramką / Frame / Einbau mit Rahmen

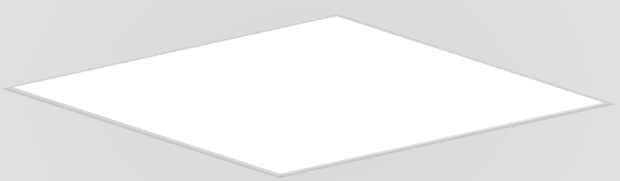

316 x 316 | 446 x 446
576 x 576 | 846 x 846 | 1126 x 1126 mm

Four mounting variants available in four colors.
Five diameters tailored to your needs.



Rink

Square C

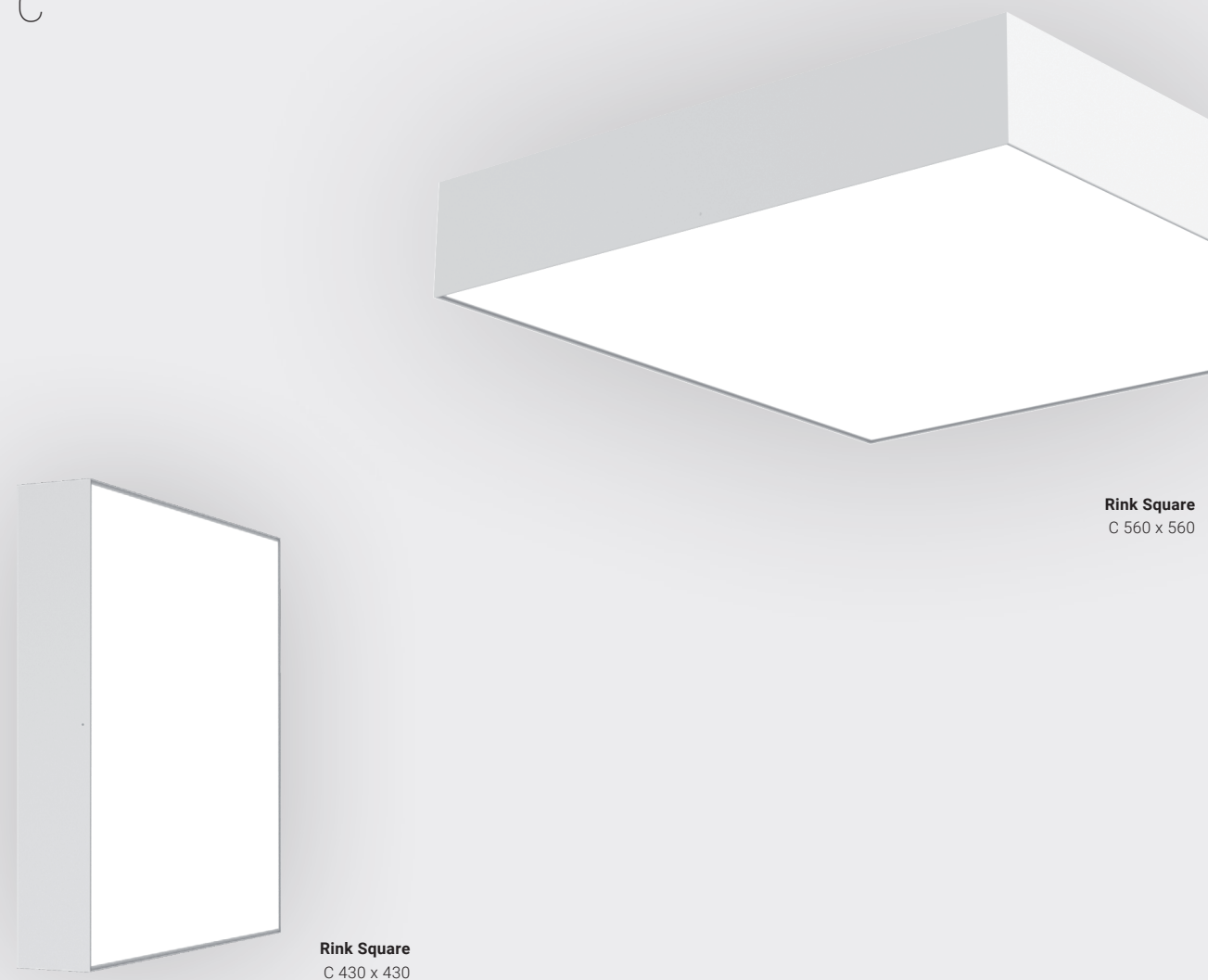

Cechy | Features | Eigenschaften

LED | 3000K / 4000K | CRI>80 | SDCM ≤ 3 | 50000h L80 B10 | IP20 | ON/OFF DALI | 220 - 240V 50-60HZ | | | Colours:

PL

Montaż: nabudowany ściana/sufit .

Źródło światła: PCB LED, 3000K / 4000K, CRI> 80, MacAdam ≤ 3,50000h L80B10.

Moc oprawy: wersja high efficiency (HE), wersja high output (HO).

Dyfuzory: satyna, mikrokrystaliczny, ciemny mikrokrystaliczny.

Rozsył światła: bezpośredni, pośredni / pośredni.

Obudowa: wytłaczany profil aluminiowy malowany proszkowo.

Sterowanie: ON/OFF lub DALI.

Stopień ochrony: IP20

EN

Mounting: built-on wall / ceiling

Light source: PCB LED, 3000K / 4000K, CRI> 80, MacAdam ≤ 3,50000h L80B10.

Luminaire power: high efficiency (HE) version, high output (HO) version.

Diffusers: satin, microcrystal dark microcrystal.

Light distribution: direct, direct / indirect.

Housing: powder coated extruded aluminum profile.

Control: ON / OFF or DALI.

IP protection: IP20

DE

Installation: angebaut Wand/Decke.

Lichtquelle: PCB LED, 3000K / 4000K, CRI> 80, MacAdam ≤ 3,50000h L80B10.

Leuchtenleistung: hohe Effizienz (HE) Version, hohe Leistung (HO) Version.

Diffusor: satiniert, Microcrystale, dunkel Microcrystale.

Lichtverteilung: Direkt, Direkt/Indirekt.

Gehäuse: Aluminium-Strangpressprofil, pulverbeschichtet.

Steuerung: EIN-AUS oder DALI.

Schutzart : IP20

Rink Sqaure C DIRECT



Type	Dimensions	Power	Luminaire flux *			Code	
			satine	microcrystal	dark microcrystal UGR<19		
Version with LED CC HE (High Efficiency)	Rinks Sqaure C	300x300 mm	8.4 W	1158 lm	1178 lm	720 lm	5.2111.01C1.fg6i.j0
	Rinks Sqaure C	430x430 mm	15 W	2063 lm	2098 lm	1283 lm	5.2111.02C1.fg6i.j0
	Rinks Sqaure C	560x560 mm	23.5 W	3243 lm	3298 lm	2016 lm	5.2111.03C1.fg6i.j0
	Rinks Sqaure C	830x830 mm	46.6 W	6431 lm	6542 lm	3999 lm	5.2111.04C1.fg6i.j0
	Rinks Sqaure C	1110x1110 mm	87.4 W	12044 lm	12251 lm	7489 lm	5.2111.05C1.fg6i.j0
Version with LED CC HO (High Output)	Rinks Sqaure C	300x300 mm	13.2 W	1734 lm	1764 lm	1078 lm	5.2111.01C1.fg7i.j0
	Rinks Sqaure C	430x430 mm	20 W	2625 lm	2670 lm	1632 lm	5.2111.02C1.fg7i.j0
	Rinks Sqaure C	560x560 mm	32.3 W	4244 lm	4317 lm	2639 lm	5.2111.03C1.fg7i.j0
	Rinks Sqaure C	830x830 mm	74.9 W	9840 lm	10008 lm	6118 lm	5.2111.04C1.fg7i.j0
	Rinks Sqaure C	1110x1110 mm	135.2 W	17753 lm	18057 lm	11039 lm	5.2111.05C1.fg7i.j0

Rink Sqaure C DIRECT/INDIRECT



Type	Dimensions	Power	Luminaire flux *			Code	
			satine	microcrystal	dark microcrystal UGR<19		
Version with LED CC HE (High Efficiency)	Rinks Sqaure C	300x300 mm	8.4 W	1135+23 lm	1155+23 lm	697+23 lm	5.2111.01B1.fg6i.j0
	Rinks Sqaure C	430x430 mm	15 W	2021+42 lm	2056+42 lm	1241+42 lm	5.2111.02B1.fg6i.j0
	Rinks Sqaure C	560x560 mm	23.5 W	3178+65 lm	3233+65 lm	1951+65 lm	5.2111.03B1.fg6i.j0
	Rinks Sqaure C	830x830 mm	46.6 W	6302+129 lm	6413+129 lm	3870+129 lm	5.2111.04B1.fg6i.j0
	Rinks Sqaure C	1110x1110 mm	87.4 W	11802+242 lm	12009+242 lm	7247+242 lm	5.2111.05B1.fg6i.j0
Version with LED CC HO (High Output)	Rinks Sqaure C	300x300 mm	13.2 W	1697+37 lm	1727+37 lm	1041+37 lm	5.2111.01B1.fg7i.j0
	Rinks Sqaure C	430x430 mm	20 W	2570+55 lm	2615+55 lm	1577+55 lm	5.2111.02B1.fg7i.j0
	Rinks Sqaure C	560x560 mm	32.3 W	4154+90 lm	4227+90 lm	2549+90 lm	5.2111.03B1.fg7i.j0
	Rinks Sqaure C	830x830 mm	74.9 W	9632+208 lm	9800+208 lm	5910+208 lm	5.2111.04B1.fg7i.j0
	Rinks Sqaure C	1110x1110 mm	135.2 W	17378+375 lm	17682+375 lm	10664+375 lm	5.2111.05B1.fg7i.j0

Strumień świetlny oprawy podany dla 4000K.
Fixture lumen output data refer to 4000K.
Lichtstrom der Leuchte spezifiziert für 4000K.

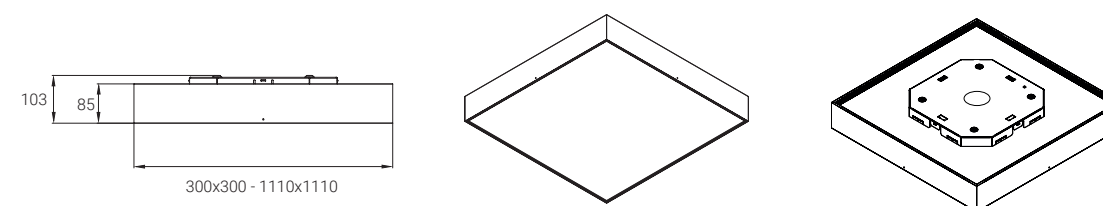

Driver	f	LED color	g	Diffuser	i	Finishing	j
ON/OFF	1	830	2	satine	1	white (RAL9016)	4
DALI	2	840	3	microcrystal	2	black (RAL9005)	5
				dark microcrystal	8	fog (RAL7038)	6
						graphite (RAL7024)	H



Rink Square S

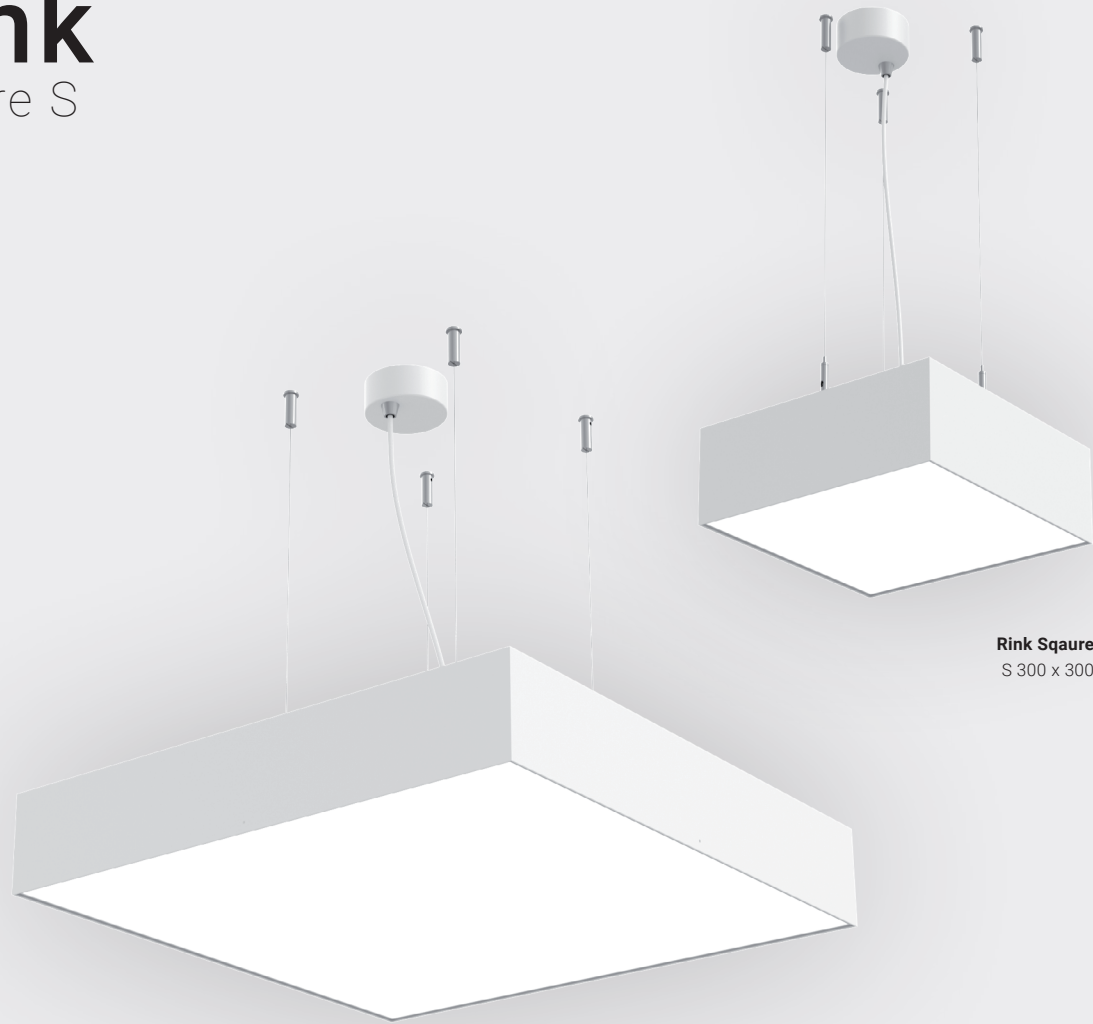

Rink Sqaure S 560 x 560

Rink Sqaure S 300 x 300

Cechy | Features | Eigenschaften

LED 3000K / 4000K CRI>80 SDCM ≤ 3 50000h L80 B10 IP20 ON/OFF DALI 220 - 240V 50-60HZ   Colours:    

PL

Montaż: zwieszany

Źródło światła: PCB LED, 3000K / 4000K, CRI> 80, MacAdam ≤ 3,50000h L80B10.

Moc oprawy: wersja high efficiency (HE), wersja high output (HO).

Dyfuzory: satyna, mikrokrystaliczny, ciemny mikrokrystaliczny.

Rozsył światła: bezpośredni, bezpośredni / pośredni.

Obudowa: wytłaczany profil aluminiowy malowany proszkowo.

Sterowanie: ON/OFF lub DALI.

Stopień ochrony: IP20

EN

Mounting: suspended

Light source: PCB LED, 3000K / 4000K, CRI> 80, MacAdam ≤ 3,50000h L80B10.

Luminaire power: high efficiency (HE) version, high output (HO) version.

Diffusers: satin, microcrystal dark microcrystal.

Light distribution: direct, direct / indirect.

Housing: powder coated extruded aluminum profile.

Control: ON / OFF or DALI.

IP protection: IP20

DE

Installation: abgependelt

Lichtquelle: PCB LED, 3000K / 4000K, CRI> 80, MacAdam ≤ 3,50000h L80B10.

Leuchtenleistung: hohe Effizienz (HE) Version, hohe Leistung (HO) Version.

Diffusor: satiniert, Microcrystale, dunkel Microcrystale.

Lichtverteilung: Direkt, Direkt/Indirekt.

Gehäuse: Aluminium-Strangpressprofil, pulverbeschichtet.

Steuerung: EIN-AUS oder DALI.

Schutzart: IP20

Rink Sqaure S DIRECT



Type	Dimensions	Power	Luminaire flux *			Code
			satine	microcrystal	dark microcrystal UGR<19	
Version with LED CC HE (High Efficiency)	Rinks Sqaure S 300x300 mm	8.4 W	1158 lm	1178 lm	720 lm	5.2112.01D1.fg6i.j0
	Rinks Sqaure S 430x430 mm	15 W	2063 lm	2098 lm	1283 lm	5.2112.02D1.fg6i.j0
	Rinks Sqaure S 560x560 mm	23.5 W	3243 lm	3298 lm	2016 lm	5.2112.03D1.fg6i.j0
	Rinks Sqaure S 830x830 mm	46.6 W	6431 lm	6542 lm	3999 lm	5.2112.04D1.fg6i.j0
	Rinks Sqaure S 1110x1110 mm	87.4 W	12044 lm	12251 lm	7489 lm	5.2112.05D1.fg6i.j0
Version with LED CC HO (High Output)	Rinks Sqaure S 300x300 mm	13.2 W	1734 lm	1764 lm	1078 lm	5.2112.01D1.fg7i.j0
	Rinks Sqaure S 430x430 mm	20 W	2625 lm	2670 lm	1632 lm	5.2112.02D1.fg7i.j0
	Rinks Sqaure S 560x560 mm	32.3 W	4244 lm	4317 lm	2639 lm	5.2112.03D1.fg7i.j0
	Rinks Sqaure S 830x830 mm	74.9 W	9840 lm	10008 lm	6118 lm	5.2112.04D1.fg7i.j0
	Rinks Sqaure S 1110x1110 mm	135.2 W	17753 lm	18057 lm	11039 lm	5.2112.05D1.fg7i.j0

Rink Sqaure S DIRECT/INDIRECT



Type	Dimensions	Power	Luminaire flux *			Code
			satine	microcrystal	dark microcrystal UGR<19	
Version with LED CC HE (High Efficiency)	Rinks Sqaure S 300x300 mm	8.4+4.3 W	1158+619 lm	1178+619 lm	720+619 lm	5.2112.01I1.fg6i.j0
	Rinks Sqaure S 430x430 mm	15+7.5 W	2063+1081 lm	2098+1081 lm	1283+1081 lm	5.2112.02I1.fg6i.j0
	Rinks Sqaure S 560x560 mm	23.5+10.8 W	3243+1544 lm	3298+1544 lm	2016+1544 lm	5.2112.03I1.fg6i.j0
	Rinks Sqaure S 830x830 mm	46.6+21.5 W	6431+3089 lm	6542+3089 lm	3999+3089 lm	5.2112.04I1.fg6i.j0
	Rinks Sqaure S 1110x1110 mm	87.4+38.8 W	12044+5563 lm	12251+5563 lm	7489+5563 lm	5.2112.05I1.fg6i.j0
Version with LED CC HO (High Output)	Rinks Sqaure S 300x300 mm	13.2+4.3 W	1734+619 lm	1764+619 lm	1078+619 lm	5.2112.01I1.fg7i.j0
	Rinks Sqaure S 430x430 mm	20+7.5 W	2625+1081 lm	2670+1081 lm	1632+1081 lm	5.2112.02I1.fg7i.j0
	Rinks Sqaure S 560x560 mm	32.3+10.8 W	4244+1544 lm	4317+1544 lm	2639+1544 lm	5.2112.03I1.fg7i.j0
	Rinks Sqaure S 830x830 mm	74.9+21.5 W	9840+3089 lm	10008+3089 lm	6118+3089 lm	5.2112.04I1.fg7i.j0
	Rinks Sqaure S 1110x1110 mm	135.2+38.8 W	17753+5563 lm	18057+5563 lm	11039+5563 lm	5.2112.05I1.fg7i.j0

Strumień świetlny oprawy podany dla 4000K.
Fixture lumen output data refer to 4000K.
Lichtstrom der Leuchte spezifiziert für 4000K.

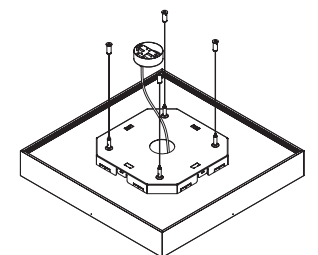
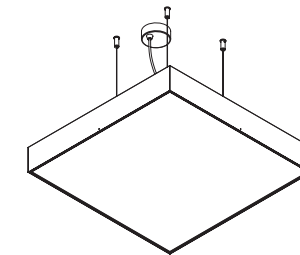
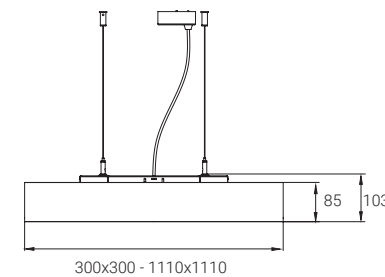

Driver	f	LED color	g	Diffuser	i	Finishing	j
ON/OFF	1	830	2	satine	1	white (RAL9016)	4
DALI	2	840	3	microcrystal	2	black (RAL9005)	5
				dark microcrystal	8	fog (RAL7038)	6
						graphite (RAL7024)	H





Rink Square P



Rink Sqaure P 300x300



Rink Sqaure P 560x560

Cechy | Features | Eigenschaften

LED 3000K / 4000K CRI>80 SDCM ≤ 3 50000h L80 B10 IP20 ON/OFF DALI 220 - 240V 50-60HZ

Colours:

PL

Montaż: zwieszany na sztywnym regulowanym uchwycie.

Źródło światła: PCB LED, 3000K / 4000K, CRI> 80, MacAdam ≤ 3,50000h L80B10.

Moc oprawy: wersja high efficiency (HE), wersja high output (HO).

Dyfuzyjność: satyna, mikrokrystaliczny, ciemny mikrokrystaliczny.

Rozsył światła: bezpośredni, pośredni / pośredni.

Obudowa: wytłaczany profil aluminiowy malowany proszkowo.

Stwierzenie: ON/OFF lub DALI.

Stopień ochrony: IP20

EN

Mounting: suspended on rigid adjustable rod

Light source: PCB LED, 3000K / 4000K, CRI> 80, MacAdam ≤ 3,50000h L80B10.

Luminaire power: high efficiency (HE) version, high output (HO) version.

Diffusers: satin, microcrystal dark microcrystal.

Light distribution: direct, direct / indirect.

Housing: powder coated extruded aluminum profile.

Control: ON / OFF or DALI.

IP protection: IP20

DE

Installation: abgependelt montiert auf einer festen, verstellbaren Halterung.

Lichtquelle: PCB LED, 3000K / 4000K, CRI> 80, MacAdam ≤ 3,50000h L80B10.

Leuchtenleistung: hohe Effizienz (HE) Version, hohe Leistung (HO) Version.

Diffusor: satiniert, Microcrystale, dunkel Microcrystale.

Lichtverteilung: Direkt, Direkt/Indirekt.

Gehäuse: Aluminium-Strangpressprofil, pulverbeschichtet.

Steuerung: EIN-AUS oder DALI.

Schutzart: IP20

Rink Sqaure P DIRECT



Type	Dimensions	Power	Luminaire flux *			Code
			satine	microcrystal	dark microcrystal UGR<19	
Version with LED CC HE (High Efficiency)	Rinks Sqaure P 300x300 mm	8.4 W	1158 lm	1178 lm	720 lm	5.2115.01D1.fg6i.j0
	Rinks Sqaure P 430x430 mm	15 W	2063 lm	2098 lm	1283 lm	5.2115.02D1.fg6i.j0
	Rinks Sqaure P 560x560 mm	23.5 W	3243 lm	3298 lm	2016 lm	5.2115.03D1.fg6i.j0
	Rinks Sqaure P 830x830 mm	46.6 W	6431 lm	6542 lm	3999 lm	5.2115.04D1.fg6i.j0
	Rinks Sqaure P 1110x1110 mm	87.4 W	12044 lm	12251 lm	7489 lm	5.2115.05D1.fg6i.j0
Version with LED CC HO (High Output)	Rinks Sqaure P 300x300 mm	13.2 W	1734 lm	1764 lm	1078 lm	5.2115.01D1.fg7i.j0
	Rinks Sqaure P 430x430 mm	20 W	2625 lm	2670 lm	1632 lm	5.2115.02D1.fg7i.j0
	Rinks Sqaure P 560x560 mm	32.3 W	4244 lm	4317 lm	2639 lm	5.2115.03D1.fg7i.j0
	Rinks Sqaure P 830x830 mm	74.9 W	9840 lm	10008 lm	6118 lm	5.2115.04D1.fg7i.j0
	Rinks Sqaure P 1110x1110 mm	135.2 W	17753 lm	18057 lm	11039 lm	5.2115.05D1.fg7i.j0

Rink Sqaure P DIRECT/INDIRECT



Type	Dimensions	Power	Luminaire flux *			Code
			satine	microcrystal	dark microcrystal UGR<19	
Version with LED CC HE (High Efficiency)	Rinks Sqaure P 300x300 mm	8.4+4.3 W	1158+619 lm	1178+619 lm	720+619 lm	5.2115.01I1.fg6i.j0
	Rinks Sqaure P 430x430 mm	15+7.5 W	2063+1081 lm	2098+1081 lm	1283+1081 lm	5.2115.02I1.fg6i.j0
	Rinks Sqaure P 560x560 mm	23.5+10.8 W	3243+1544 lm	3298+1544 lm	2016+1544 lm	5.2115.03I1.fg6i.j0
	Rinks Sqaure P 830x830 mm	46.6+21.5 W	6431+3089 lm	6542+3089 lm	3999+3089 lm	5.2115.04I1.fg6i.j0
	Rinks Sqaure P 1110x1110 mm	87.4+38.8 W	12044+5563 lm	12251+5563 lm	7489+5563 lm	5.2115.05I1.fg6i.j0
Version with LED CC HO (High Output)	Rinks Sqaure P 300x300 mm	13.2+4.3 W	1734+619 lm	1764+619 lm	1078+619 lm	5.2115.01I1.fg7i.j0
	Rinks Sqaure P 430x430 mm	20+7.5 W	2625+1081 lm	2670+1081 lm	1632+1081 lm	5.2115.02I1.fg7i.j0
	Rinks Sqaure P 560x560 mm	32.3+10.8 W	4244+1544 lm	4317+1544 lm	2639+1544 lm	5.2115.03I1.fg7i.j0
	Rinks Sqaure P 830x830 mm	74.9+21.5 W	9840+3089 lm	10008+3089 lm	6118+3089 lm	5.2115.04I1.fg7i.j0
	Rinks Sqaure P 1110x1110 mm	135.2+38.8 W	17753+5563 lm	18057+5563 lm	11039+5563 lm	5.2115.05I1.fg7i.j0

Strumień świetlny oprawy podany dla 4000K.
Fixture lumen output data refer to 4000K.
Lichtstrom der Leuchte spezifiziert für 4000K.

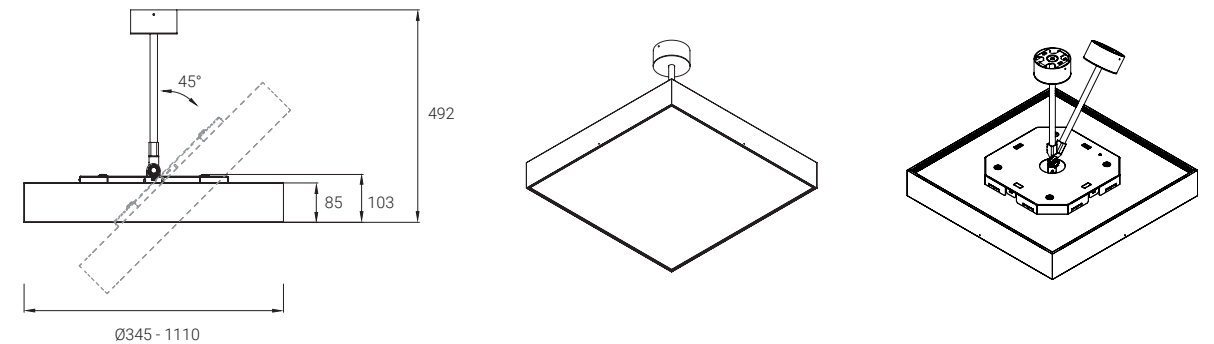

Driver	f	LED color	g	Diffuser	i	Finishing	j
ON/OFF	1	830	2	satine	1	white (RAL9016)	4
DALI	2	840	3	microcrystal	2	black (RAL9005)	5
				dark microcrystal	8	fog (RAL7038)	6
						graphite (RAL7024)	H



Rink

Square F

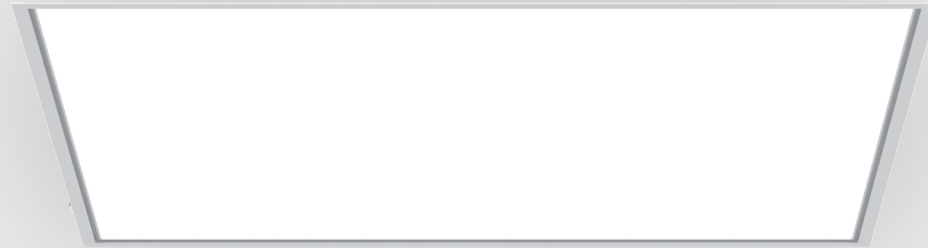

Rink Sqaure
F 576 x 576



Rink Sqaure
F 316 x 316

Cechy | Features | Eigenschaften

LED 3000K / 4000K CRI>80 SDCM ≤ 3 50000h L80 B10 IP20 ON/OFF DALI 220 - 240V 50-60HZ

Colours:

PL

Montaż: wbudowany z ramką.

Źródło światła: PCB LED, 3000K / 4000K, CRI> 80, MacAdam ≤ 3,50000h L80B10.

Moc oprawy: wersja high efficiency (HE), wersja high output (HO).

Dyfuzory: satyna, mikrokrystaliczny, ciemny mikrokrystaliczny.

Rozsył światła: bezpośredni

Obudowa: wytłaczany profil aluminiowy malowany proszkowo.

Stewowanie: ON/OFF lub DALI.

Stopień ochrony: IP20

EN

Mounting: recessed with a frame.

Light source: PCB LED, 3000K / 4000K, CRI> 80, MacAdam ≤ 3,50000h L80B10.

Luminaire power: high efficiency (HE) version, high output (HO) version.

Diffusers: satin, microcrystal dark microcrystal.

Light distribution: direct

Housing: powder coated extruded aluminum profile.

Control: ON / OFF or DALI.

IP protection: IP20

DE

Installation: Eingebaut mit Rahmen.

Lichtquelle: PCB LED, 3000K / 4000K, CRI> 80, MacAdam ≤ 3,50000h L80B10.

Leuchtenleistung: hohe Effizienz (HE) Version, hohe Leistung (HO) Version.

Diffuser: satiniert, Microcrystale, dunkel Microcrystale.

Lichtverteilung: Direkt.

Gehäuse: Aluminium-Strangpressprofil, pulverbeschichtet..

Steuerung: EIN-AUS oder DALI.

Schutzart: IP20

Rink Sqaure F DIRECT



Type	Dimensions	Power	Luminaire flux *			Code
			satine	microcrystal	dark microcrystal UGR<19	
Version with LED CC HE (High Efficiency)	Rinks Sqaure F 316x316 mm	8.4 W	1158 lm	1178 lm	720 lm	5.2113.01F1.fg6i.j0
	Rinks Sqaure F 446x446 mm	15 W	2063 lm	2098 lm	1283 lm	5.2113.02F1.fg6i.j0
	Rinks Sqaure F 576x576 mm	23.5 W	3243 lm	3298 lm	2016 lm	5.2113.03F1.fg6i.j0
	Rinks Sqaure F 846x846 mm	46.6 W	6431 lm	6542 lm	3999 lm	5.2113.04F1.fg6i.j0
Rinks Sqaure F 1126x1126 mm	87.4 W	12044 lm	12251 lm	7489 lm	5.2113.05F1.fg6i.j0	
Version with LED CC HO (High Output)	Rinks Sqaure F 316x316 mm	13.2 W	1734 lm	1764 lm	1078 lm	5.2113.01F1.fg7i.j0
	Rinks Sqaure F 446x446 mm	20 W	2625 lm	2670 lm	1632 lm	5.2113.02F1.fg7i.j0
	Rinks Sqaure F 576x576 mm	32.3 W	4244 lm	4317 lm	2639 lm	5.2113.03F1.fg7i.j0
	Rinks Sqaure F 846x846 mm	74.9 W	9840 lm	10008 lm	6118 lm	5.2113.04F1.fg7i.j0
	Rinks Sqaure F 1126x1126 mm	135.2 W	17753 lm	18057 lm	11039 lm	5.2113.05F1.fg7i.j0

L1 - 10 x L2 - 10 mm | Hmin = 130 mm

Strumień świetlny oprawy podany dla 4000K.
Fixture lumen output data refer to 4000K.
Lichtstrom der Leuchte spezifiziert für 4000K.

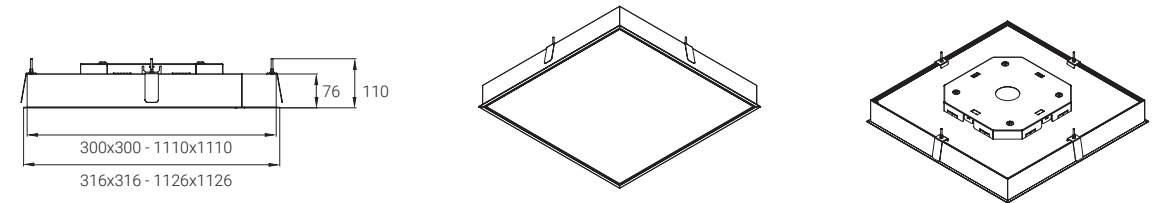
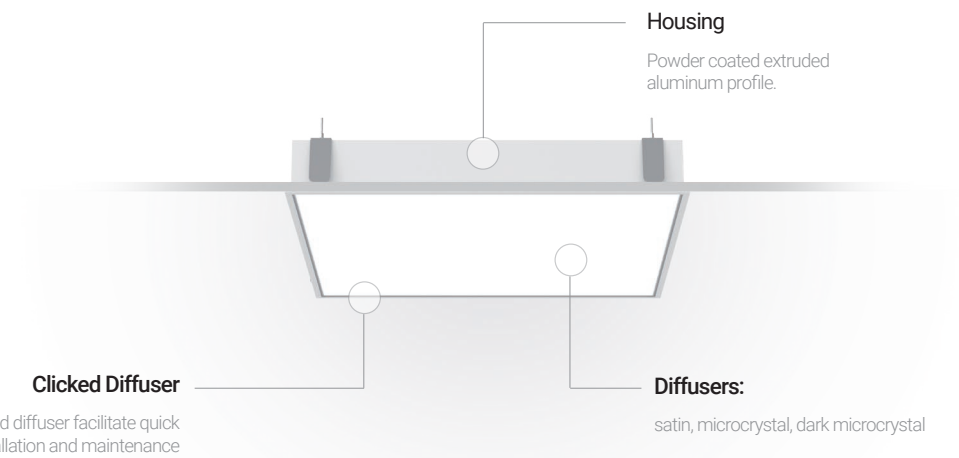

Driver	f	LED color	g	Diffuser	i	Finishing	j
ON/OFF	1	830	2	satine	1	white (RAL9016)	4
DALI	2	840	3	microcrystal	2	black (RAL9005)	5
				dark microcrystal	8	fog (RAL7038)	6
						graphite (RAL7024)	H







ORGANIC LIGHTING

ul. 1 Maja 46a
05-555 Tarczyn, Poland
tel: +48 22 736 73 00
info@organiclighting.eu



