

# Loop

Line | Chili

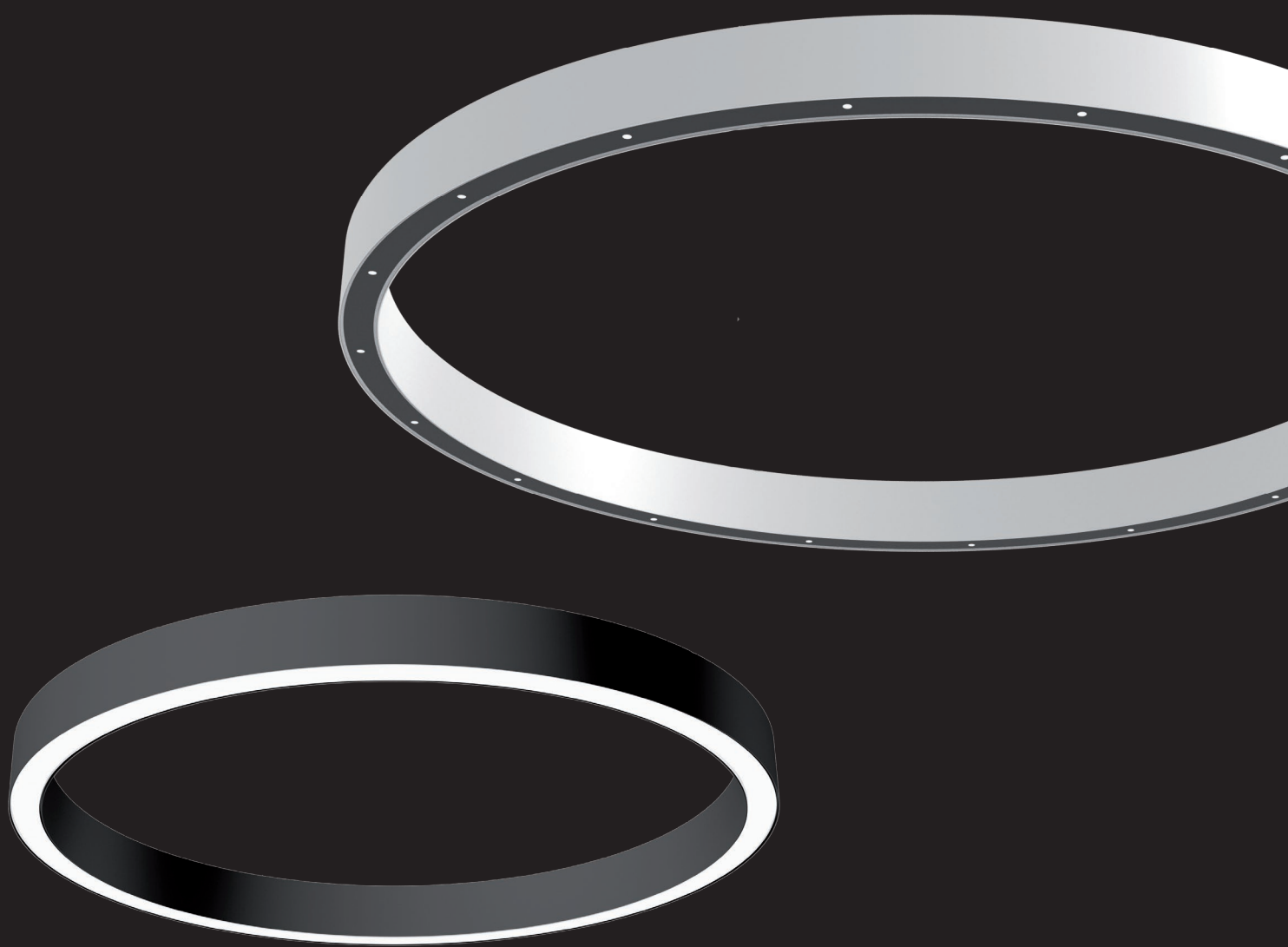

## **Our mission is healthy light.**

We create human and environment – friendly solutions: natural, comfortable to the eye, rendering genuine colours. We believe in timeless and universal aesthetics. We design lamps that are minimalist in their form, and which can complement both traditional and modern architecture. To draw up custom designs, we approach each interior from a fresh perspective.

Quality is at the core of our work. All of our products are manufactured in our own factory in Tarczyn, with the help of a team of lighting experts – technology and product engineers. For 20 years, we have completed a plethora of projects, and each of them represents how we understand the culture of light and the way light can be experienced in space. When considering the role of light in contemporary architecture, one cannot disregard the history of Bauhaus. The school, or rather a free, creative collective of architects, artists and artisans, is celebrating its centenary year.

Light was of the building blocks of architecture in Modernism. In those times, as a result of technological progress electric light became just as important building material as concrete or steel. Shaping the experience of space through artificial light in buildings was an entirely new challenge for Bauhaus architects and designers. Their avant-garde approach to materials and forms, combined with the consolidation of modernist standards in terms of aesthetics and form in the middle of the 20th century, became the foundation for contemporary design.

Today, when looking at Infinite numbers of light fixtures and lamps, it is easy to forget that today's lighting culture has its roots in the school of Bauhaus and owe sit its shape.





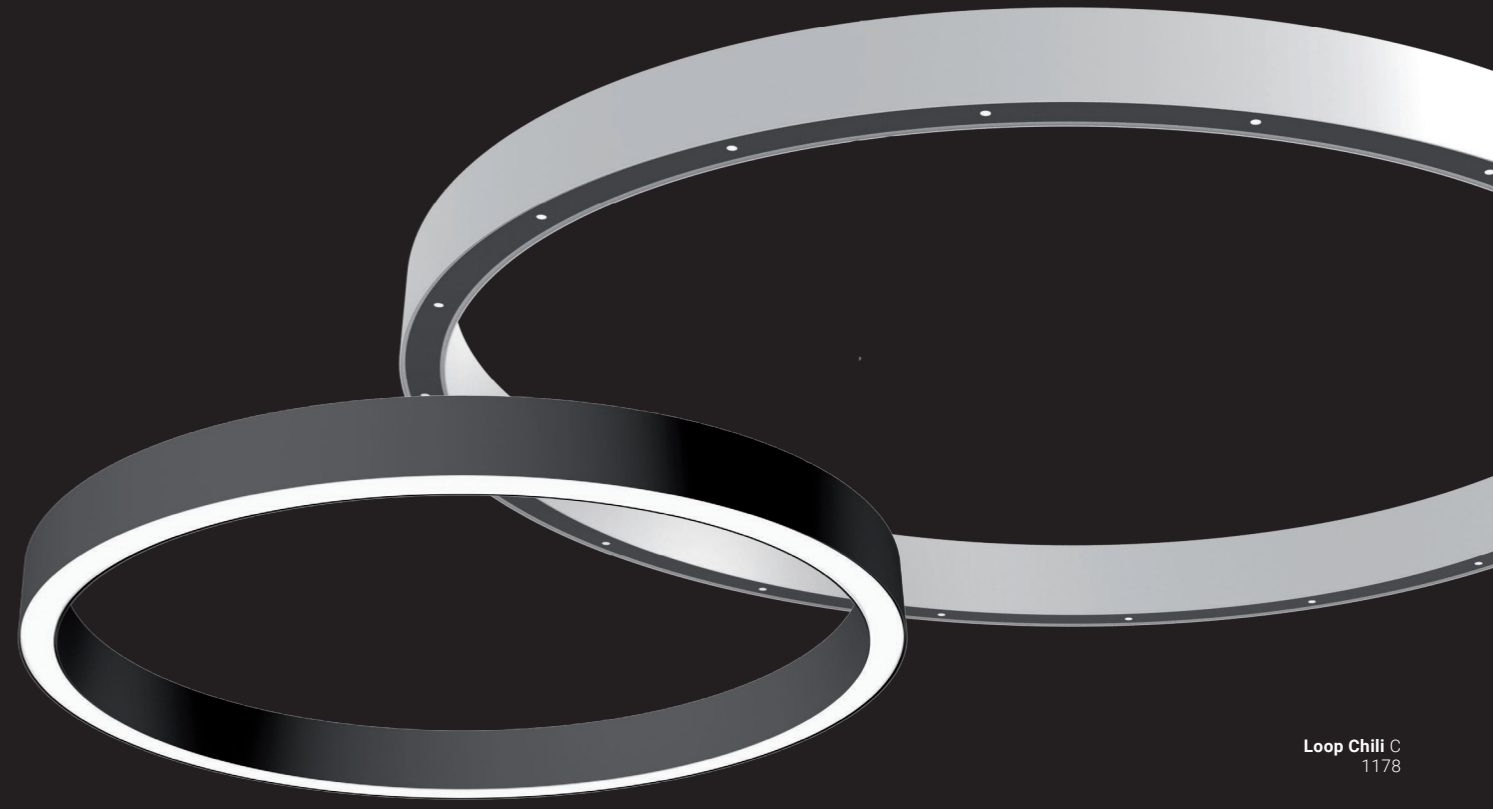

**Loop Line C**  
896

**Loop Chili C**  
1178

**Profile gięte z dyfuzorem satynowym, mikrokryształicznym, ciemnym mikrokryształicznym, mikropryzmatycznym lub oświetleniem punktowym CHILI.**

Specjalna optyka LFO zapewnia komfortowe i miękkie światło przy bardzo dobrych współczynnikach ograniczenia oślnienia. Jedenaście rozmiarów (od 60 cm do 6 metrów średnicy) dostępne w różnych kolorach i kilka krzywych koła, połącz je ze sobą i stwórz coś wyjątkowego w swoim rodzaju.

**Curved profiles with satin, microcrystal, dark microcrystal, microprismatic diffusers or CHILI spots.**

Special LFO optics provide comfortable and soft light with very good glare limitation factors. Eleven sizes (from 60 cm to 6 meters in diameter) available in different colors and a several curves of the circle, connect them together and create something one of a kind.

**Gebogene Profile mit der Abdeckung: satiniert, Microcrystale, dunkel Microcrystale, Mikroprisma oder CHILI-Strahler.**

Die spezielle LFO-Optik sorgt für angenehmes und weiches Licht mit sehr niedrigen Blendungsfaktor. Elf Größen (von 60 cm bis 6 Meter Durchmesser) in verschiedenen Farben und mehreren Kreisbögen stehen zur Verfügung. Kombinieren Sie sie miteinander und schaffen Sie etwas Einzigartiges in seiner Art.





### Loop Line

Nabudowany / Ceiling build-on / Deckenbefestigung  
Zwieszany / Suspended / Abgehängt

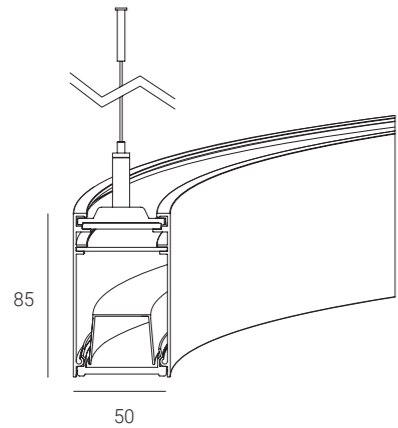

### Loop Chili

Nabudowany / Ceiling build-on / Deckenbefestigung  
Zwieszany / Suspended / Abgehängt

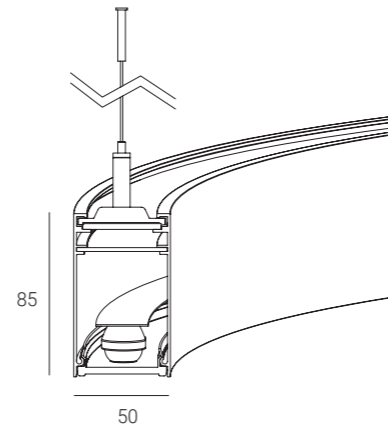

### Loop

Central ceiling cup

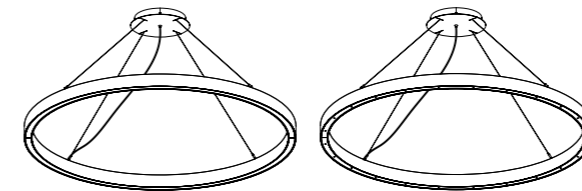

Loop Line

Loop Chili

### Loop

Side ceiling cup

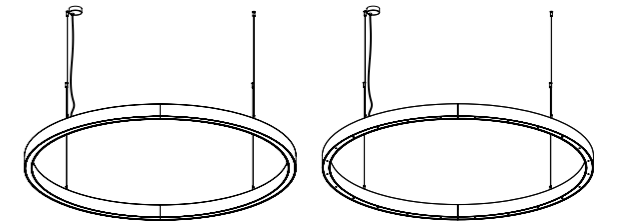

Loop Line

Loop Chili

#### Diameter

Ø 614 mm  
Ø 770 mm  
Ø 896 mm  
Ø 1178 mm  
Ø 1500 mm  
Ø 1742 mm

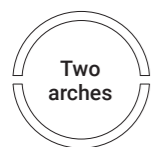

Two arches

#### Diameter

Ø 2306 mm

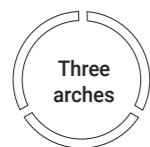

Three arches

#### Diameter

Ø 3000 mm

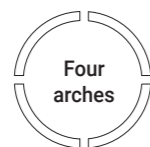

Four arches

#### Diameter

Ø 4100 mm

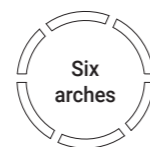

Six arches

#### Diameter

Ø 5100 mm

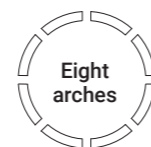

Eight arches

#### Diameter

Ø 6000 mm

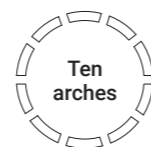

Ten arches

Diameter	No. of arches	No. of BB-Chili	No. of suspensions
Ø614mm	2	8	4
Ø770mm	2	10	4
Ø896mm	2	12	4
Ø1178mm	2	16	4
Ø1500mm	2	20	4
Ø1742mm	2	24	4
Ø2306mm	3	32	6
Ø3000mm	4	40	8
Ø4100mm	6	54	12
Ø5100mm	8	64	16
Ø6000mm	10	80	20

### Kolory

Colors  
Farben



white  
RAL 9016

fog  
RAL 7038

graphite  
RAL 7024

black  
RAL 9005

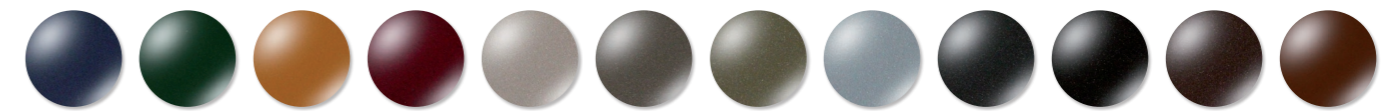

saphire  
RAL 5003

forrest  
RAL 6005

ochra

wine  
RAL 3005

sandy

earth

sage

cloudy

night

black dust

volcano

marrone

W zależności od średnicy oprawy Loop składają się z różnej liczby łuków.

Depending on the diameter, Loop luminaires consist of a different number of arches.

Je nach Durchmesser bestehen die Loop-Leuchten aus einer unterschiedlichen Anzahl von Bögen.

Inne kolory dostępne na zamówienie.  
Other colors available on demand.  
Andere Farben sind auf Anfrage erhältlich.





### Technologia LFO

Opracowana przez naukowców w laboratorium Bartenbach w Austrii, przy udziale których firma Organic Lighting stworzyła linię nowoczesnych opraw oświetleniowych - CHILI. Jej największą siłą tkwi w tym, czego nie widać, gdyż światło projekt optyki sprawia, że światło skupiane jest w maksymalnie małej przestrzeni, a następnie w niezauważalny sposób rozprasza się w pomieszczeniu.

### LFO technology

Developed by scientists at the Bartenbach laboratory in Austria, with the participation of which Organic Lighting has created a line of modern lighting fixtures - CHILI. Its greatest strength lies in what you can not see, because the light is emitted in a way that is invisible to the eye. In this innovative optics design, light is concentrated in a maximally small space, and then invisibly disperses in the room.

### LFO-Technologie

Wurde von Wissenschaftlern im Bartenbach-Labor in Österreich entwickelt und die Organic Lighting bei der Gestaltung seiner Linie moderner Leuchten – CHILI – eingesetzt hat. Seine größte Stärke liegt in dem, was man nicht sehen kann, denn das Licht wird auf eine Weise abgestrahlt, die für das Auge unsichtbar ist. Das innovative Design der Optik sorgt dafür, dass sich das Licht auf kleinstem Raum konzentriert und sich dann unmerklich im Raum verteilt.



### Zdrowe światło

Dzięki niskiemu wskaźnikowi UGR <19, efekt olśnienia jest zredukowany, zapewniając ekskluzywną jakość oświetlenia i absolutny komfort widzenia.

### Healthy light

Thanks to the low UGR index <19, the glare effect is reduced and exclusive lighting quality and absolute visual comfort are achieved.

### Gesundes Licht

Dank des niedrigen UGR-Index <19, wird die Blendwirkung reduziert und eine exklusive Beleuchtungsqualität und absoluter Sehkomfort erreicht.







# Loop

Line, Chili



Loop Line, Chili

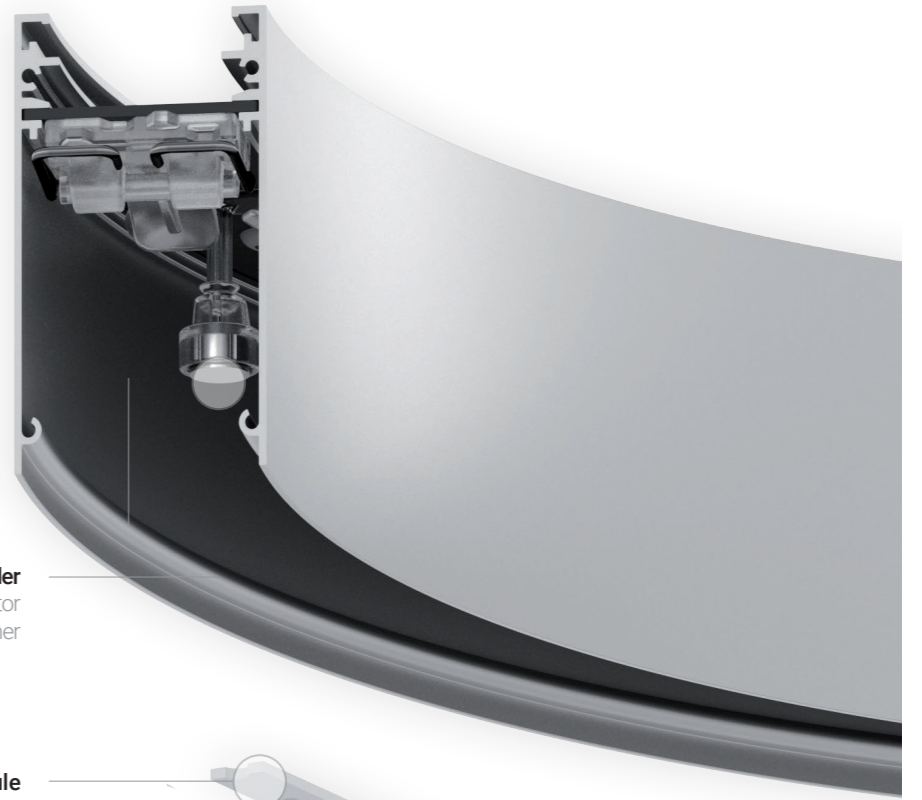

**Magnetic holder**  
Magnetic holder holding down the radiator and other accessories together

**LED module**  
LED module on an aluminum base designed specifically by ILUM.

**Bartenbach LFO lens**  
Bartenbach LFO lens - specially designed optics form the light in such a way that it is possible to hide the light source and shine through a small hole. It minimizes the glare effect and provides the functionality of a standard lens



**The lens cover**  
The lens cover made of silicone rubber modulates the light beam in a way to emit as much as possible light outside.





### Rozsył światła - bezpośredni

Dyfuzor dla oświetlenia liniowego: satynowy, mikrokrystaliczny, ciemny mikrokrystaliczny, mikropryzmatyczny.

### Light distribution - direct

Diffuser for linear lighting: satin, microcrystal, dark microcrystal, microprism.

### Lichtverteilung - direkt

Diffusor für lineare Beleuchtung: satiniert, Microcrystale, dunkel Microcrystale, Mikroprisma.

### Rozsył światła - pośredni

Tylko z satynowym dyfuzorem

### Light distribution - indirect

Always with satin diffuser

### Lichtverteilung - indirekt

Nur mit Satiniert

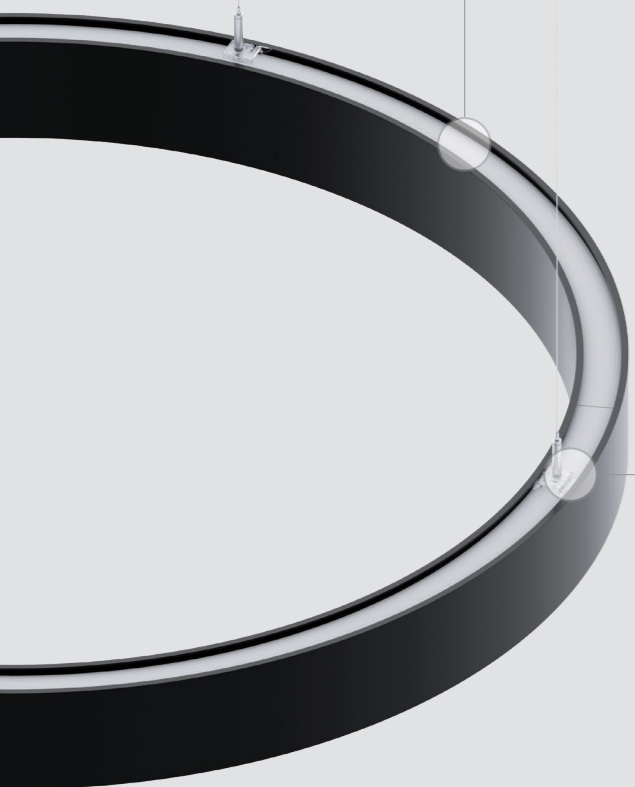

### Mikropozycjoner

Za jego pomocą możemy dowolnie regulować wysokość zawieszenia oprawy z dokładnością do 1 mm. Możliwość zmiany położenia mikropozycjonera.

### Micropositioner

With it you can freely adjust the height of the luminaire suspension with an accuracy of 1 mm. It is possible to change the position of the micropositioner.

### Mikropositionierer

Mit ihm können Sie die Höhe der Leuchtaufhängung frei einstellen mit einer Genauigkeit von 1 mm. Möglichkeit, die Position des Mikropositionierers zu verändern.

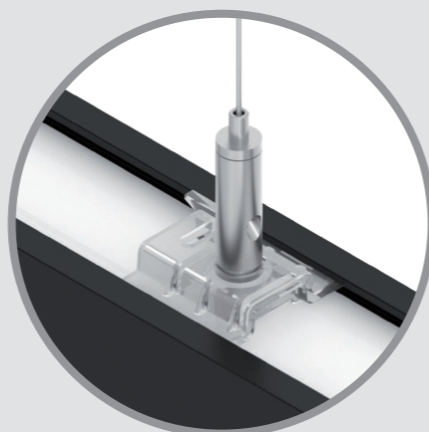

### System by Bartebach LFO optic

W technologii CHILI światło jest wypuszczane na zewnątrz oprawy przez 9-milimetrowy otwór. Oprawa występuje w dwóch wersjach kąta rozsyłu: 30° i 60°.

### System by Bartebach LFO optic

In CHILI technology, the light comes out of the luminaire through 9 mm hole. The luminaire comes in two versions of the beam angle: 30° and 60°.

### System von Bartebach LFO Optik

System von Bartebach LFO-Optik. Bei der CHILI-Technologie wird das Licht außerhalb der Leuchte durch eine 9 mm große Öffnung abgegeben. Die Leuchte ist in zwei Varianten des Abstrahlwinkels erhältlich: 30° und 60°.

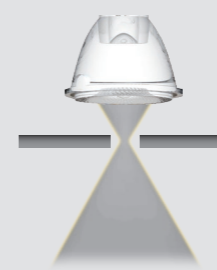

System by Bartebach LFO optic

### Wybierz swój kolor

Choose your color  
Wählen Sie Ihre Farbe









# Loop

Line, Chili

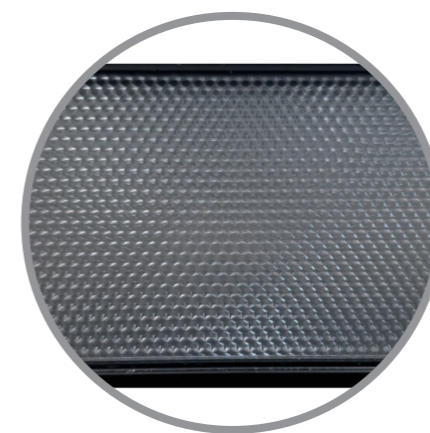

Ciemny dyfuzor mikrokrystaliczny o strukturze heksagonalnej zapewniający ochronę antyodświecenia z wielu kierunków obserwacji.

Dark microcrystalline diffuser with hexagonal structure for anti-glare protection from multiple viewing directions.

Dunkel mikrokrystalliner Diffusor mit sechseckiger Struktur für Blendschutz aus mehreren Blickrichtungen.

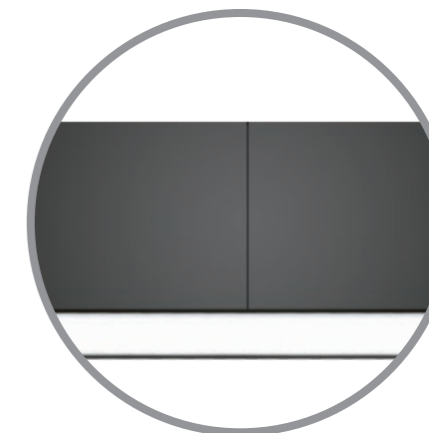

Łączenie profili w sposób eliminujący świecenie przez szczeliny.

Connection of profiles in a way that eliminates the risk of glowing through the gaps.

Die Profile sind in einer Weise verbunden, die das Risiko des Leuchtens durch die Lücken ausschließt.



Wystłony - łączenie profili w sposób eliminujący świecenie przez szczeliny.

Black screens - connection of profiles in a way eliminating lighting gaps.

Blenden - Profile so verbinden, dass kein Licht durch Lücken scheint.



Zapięcie mechaniczne pozwalające na beznarzędziowe łączenie modułów systemu.

Mechanical lock allowing to connect the system modules without any tools.

Mechanisches Verbindungselement, das eine werkzeuglose Verbindung von Systemmodulen ermöglicht.





# Loop

## Line C



Loop Line  
C 770



Loop Line  
C 1178

### Cechy | Features | Eigenschaften

LED	3000K 4000K	CRI>80	SDCM ≤ 3	50000h L80 B10	IP20	ON/OFF DALI	220 - 240V 50-60HZ		
-----	----------------	--------	----------	-------------------	------	----------------	-----------------------	--	--

### Colors:

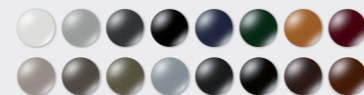

PL

**Montaż:** nabudowany.

**Źródło światła:** PCB LED, 3000K / 4000K, CRI> 80, MacAdam ≤ 3,50000h L80B10.

**Moc oprawy:** wersja high efficiency (HE), wersja high output (HO).

**Dyfuzory:** satyna, mikrokrystaliczny, ciemny mikrokrystaliczny, mikropryzmatyczny.

**Rozsył światła:** bezpośredni.

**Obudowa:** wytłaczany profil aluminiowy malowany proszkowo.

**Sterowanie:** ON/OFF lub DALI.

**Stopień ochrony:** IP20

EN

**Mounting:** ceiling built-on.

**Light source:** PCB LED, 3000K / 4000K, CRI> 80, MacAdam ≤ 3,50000h L80B10.

**Luminaire power:** high efficiency (HE) version, high output (HO) version.

**Diffusers:** satin, microcrystal dark microcrystal, microprism.

**Light distribution:** direct.

**Housing:** powder coated extruded aluminum profile.

**Control:** ON / OFF or DALI.

**IP protection:** IP20

DE

**Installation:** angebaut.

**Lichtquelle:** PCB LED, 3000K / 4000K, CRI> 80, MacAdam ≤ 3,50000h L80B10.

**Leuchtenleistung:** hohe Effizienz (HE) Version, hohe Leistung (HO) Version.

**Diffusor:** satiniert, Microcrystale, dunkel Microcrystale, Mikroprisma.

**Lichtverteilung:** Direkt.

**Gehäuse:** Aluminium-Strangpressprofil, pulverbeschichtet.

**Steuerung:** EIN-AUS oder DALI.

**Schutzart:** IP20

## Loop Line C DIRECT



Version with  
LED CC HE  
(High Efficiency)



Version with  
LED CC HO  
(High Output)

Version with  
LED CC HO  
(High Output)

Type	Dimensions	Power	Luminaire flux *			Code
			satine/microcrystal	dark microcrystal UGR<19	microprism UGR<19	
Loop Line C	Ø614 mm	26 W	2975 lm	2087 lm	2398 lm	5.2001.01C1.fg6i.j0
Loop Line C	Ø770mm	34 W	3966 lm	2782 lm	3197 lm	5.2001.02C1.fg6i.j0
Loop Line C	Ø896 mm	39 W	4462 lm	3130 lm	3596 lm	5.2001.03C1.fg6i.j0
Loop Line C	Ø1178 mm	52 W	5950 lm	4174 lm	4795 lm	5.2001.04C1.fg6i.j0
Loop Line C	Ø1500 mm	69 W	7933 lm	5565 lm	6394 lm	5.2001.05C1.fg6i.j0
Loop Line C	Ø1742 mm	77 W	8924 lm	6260 lm	7193 lm	5.2001.06C1.fg6i.j0
Loop Line C	Ø2306 mm	103 W	11899 lm	8347 lm	9590 lm	5.2001.07C1.fg6i.j0
Loop Line C	Ø3000 mm	138 W	15866 lm	11130 lm	12787 lm	5.2001.08C1.fg6i.j0
Loop Line C	Ø4100 mm	193 W	22311 lm	15651 lm	17982 lm	5.2001.09C1.fg6i.j0
Loop Line C	Ø5100 mm	241 W	27765 lm	19477 lm	22378 lm	5.2001.10C1.fg6i.j0
Loop Line C	Ø6000 mm	280 W	32227 lm	22607 lm	25974 lm	5.2001.11C1.fg6i.j0
			satine/microcrystal	dark microcrystal		
Loop Line C	Ø614 mm	52 W	5520 lm	3790 lm		5.2001.01C1.fg7i.j0
Loop Line C	Ø770mm	69 W	7361 lm	4946 lm		5.2001.02C1.fg7i.j0
Loop Line C	Ø896 mm	78 W	8281 lm	5564 lm		5.2001.03C1.fg7i.j0
Loop Line C	Ø1178 mm	104 W	11041 lm	7419 lm		5.2001.04C1.fg7i.j0
Loop Line C	Ø1500 mm	138 W	14721 lm	9892 lm		5.2001.05C1.fg7i.j0
Loop Line C	Ø1742 mm	156 W	16561 lm	11128 lm		5.2001.06C1.fg7i.j0
Loop Line C	Ø2306 mm	208 W	22082 lm	14838 lm		5.2001.07C1.fg7i.j0
Loop Line C	Ø3000 mm	277 W	29443 lm	19784 lm		5.2001.08C1.fg7i.j0
Loop Line C	Ø4100 mm	389 W	41404 lm	27821 lm		5.2001.09C1.fg7i.j0
Loop Line C	Ø5100 mm	484 W	51524 lm	34621 lm		5.2001.10C1.fg7i.j0
Loop Line C	Ø6000 mm	562 W	59805 lm	40186 lm		5.2001.11C1.fg7i.j0
				microprism UGR<19		
Loop Line C	Ø614 mm	34 W		2958 lm		5.2001.01C1.fg73.j0
Loop Line C	Ø770mm	46 W		3944 lm		5.2001.02C1.fg73.j0
Loop Line C	Ø896 mm	51 W		4437 lm		5.2001.03C1.fg73.j0
Loop Line C	Ø1178 mm	68 W		5916 lm		5.2001.04C1.fg73.j0
Loop Line C	Ø1500 mm	91 W		7887 lm		5.2001.05C1.fg73.j0
Loop Line C	Ø1742 mm	102 W		8873 lm		5.2001.06C1.fg73.j0
Loop Line C	Ø2306 mm	137 W		11831 lm		5.2001.07C1.fg73.j0
Loop Line C	Ø3000 mm	182 W		15775 lm		5.2001.08C1.fg73.j0
Loop Line C	Ø4100 mm	256 W		22183 lm		5.2001.09C1.fg73.j0
Loop Line C	Ø5100 mm	319 W		27606 lm		5.2001.10C1.fg73.j0
Loop Line C	Ø6000 mm	370 W		32042 lm		5.2001.11C1.fg73.j0

Strumień świetlny oprawy podany dla 4000K.  
Fixture lumen output data refer to 4000K.  
Lichtstrom der Leuchte spezifiziert für 4000K.

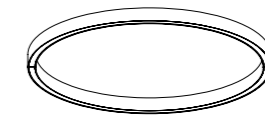

Ø614 - 1742 mm

Driver	f	LED color	g	Diffuser	i	Finishing	j	k	
ON/OFF	1	830	2	satine	1	white (RAL9016)	4	sandy	D
DALI	2	840	3	microcrystal	2	black (RAL9005)	5	earth	E
				microprism	3	fog (RAL7038)	G	sage	A
				dark microcrystal	8	graphite (RAL7024)	H	cloudy	C
						saphire (RAL5003)	S	night	N
						forrest (RAL6005)	F	black dust	B
						wine (RAL3005)	W	volcano	V
						ochra	O	marrone	M



# Loop

## Line S



Loop Line (central)  
S 1178



Loop Line (side)  
S 614

### Cechy | Features | Eigenschaften

LED	3000K 4000K	CRI>80	SDCM ≤ 3	50000h L80 B10	IP20	ON/OFF DALI	220 - 240V 50-60HZ		CE
-----	----------------	--------	----------	-------------------	------	----------------	-----------------------	--	----

### Colors:

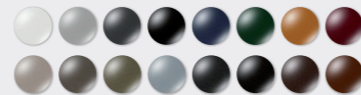

PL

**Montaż:** zwieszany

**Źródło światła:** PCB LED, 3000K / 4000K, CRI> 80, MacAdam ≤ 3,50000h L80B10.

**Moc oprawy:** wersja high efficiency (HE), wersja high output (HO).

**Dyfuzory:** satyna, mikrokryształiczny, ciemny mikrokryształiczny, mikropryzmatyczny.

**Rozsył światła:** bezpośredni.

**Obudowa:** wytłaczany profil aluminiowy malowany proszkowo.

**Sterowanie:** ON/OFF lub DALI.

**Stopień ochrony:** IP20

EN

**Mounting:** suspended

**Light source:** PCB LED, 3000K / 4000K, CRI> 80, MacAdam ≤ 3,50000h L80B10.

**Luminaire power:** high efficiency (HE) version, high output (HO) version.

**Diffusers:** satin, microcrystal dark microcrystal, microprism.

**Light distribution:** direct.

**Housing:** powder coated extruded aluminum profile.

**Control:** ON / OFF or DALI.

**IP protection:** IP20

DE

**Installation:** abgependelt

**Lichtquelle:** PCB LED, 3000K / 4000K, CRI> 80, MacAdam ≤ 3,50000h L80B10.

**Leuchtenleistung:** hohe Effizienz (HE) Version, hohe Leistung (HO) Version.

**Diffusor:** satiniert, Microcrystale, dunkel Microcrystale, Mikroprisma.

**Lichtverteilung:** Direkt.

**Gehäuse:** Aluminium-Strangpressprofil, pulverbeschichtet.

**Steuerung:** EIN-AUS oder DALI.

**Schutzart:** IP20

## Loop Line S DIRECT



Version with  
LED CC HE  
(High Efficiency)



Version with  
LED CC HO  
(High Output)



Version with  
LED CC HO  
(High Output)



Type	Dimensions	Power	Luminaire flux *			Code
			satine/microcrystal	dark microcrystal UGR<19	microprism UGR<19	
Loop Line S	Ø614 mm	26 W	2975 lm	2087 lm	2398 lm	5.200b.01D1.fg6i.j0
Loop Line S	Ø770mm	34 W	3966 lm	2782 lm	3197 lm	5.200b.02D1.fg6i.j0
Loop Line S	Ø896 mm	39 W	4462 lm	3130 lm	3596 lm	5.200b.03D1.fg6i.j0
Loop Line S	Ø1178 mm	52 W	5950 lm	4174 lm	4795 lm	5.200b.04D1.fg6i.j0
Loop Line S	Ø1500 mm	69 W	7933 lm	5565 lm	6394 lm	5.200b.05D1.fg6i.j0
Loop Line S	Ø1742 mm	77 W	8924 lm	6260 lm	7193 lm	5.200b.06D1.fg6i.j0
Loop Line S	Ø2306 mm	103 W	11899 lm	8347 lm	9590 lm	5.2003.07D1.fg6i.j0
Loop Line S	Ø3000 mm	138 W	15866 lm	11130 lm	12787 lm	5.2003.08D1.fg6i.j0
Loop Line S	Ø4100 mm	193 W	22311 lm	15651 lm	17982 lm	5.2003.09D1.fg6i.j0
Loop Line S	Ø5100 mm	241 W	27765 lm	19477 lm	22378 lm	5.2003.10D1.fg6i.j0
Loop Line S	Ø6000 mm	280 W	32227 lm	22607 lm	25974 lm	5.2003.11D1.fg6i.j0
			satine/microcrystal	dark microcrystal		
Loop Line S	Ø614 mm	52 W	5520 lm	3790 lm		5.200b.01D1.fg7i.j0
Loop Line S	Ø770mm	69 W	7361 lm	4946 lm		5.200b.02D1.fg7i.j0
Loop Line S	Ø896 mm	78 W	8281 lm	5564 lm		5.200b.03D1.fg7i.j0
Loop Line S	Ø1178 mm	104 W	11041 lm	7419 lm		5.200b.04D1.fg7i.j0
Loop Line S	Ø1500 mm	138 W	14721 lm	9892 lm		5.200b.05D1.fg7i.j0
Loop Line S	Ø1742 mm	156 W	16561 lm	11128 lm		5.200b.06D1.fg7i.j0
Loop Line S	Ø2306 mm	208 W	22082 lm	14838 lm		5.2003.07D1.fg7i.j0
Loop Line S	Ø3000 mm	277 W	29443 lm	19784 lm		5.2003.08D1.fg7i.j0
Loop Line S	Ø4100 mm	389 W	41404 lm	27821 lm		5.2003.09D1.fg7i.j0
Loop Line S	Ø5100 mm	484 W	51524 lm	34621 lm		5.2003.10D1.fg7i.j0
Loop Line S	Ø6000 mm	562 W	59805 lm	40186 lm		5.2003.11D1.fg7i.j0
				microprism UGR<19		
Loop Line S	Ø614 mm	34 W		2958 lm		5.200b.01D1.fg73.j0
Loop Line S	Ø770mm	46 W		3944 lm		5.200b.02D1.fg73.j0
Loop Line S	Ø896 mm	51 W		4437 lm		5.200b.03D1.fg73.j0
Loop Line S	Ø1178 mm	68 W		5916 lm		5.200b.04D1.fg73.j0
Loop Line S	Ø1500 mm	91 W		7887 lm		5.200b.05D1.fg73.j0
Loop Line S	Ø1742 mm	102 W		8873 lm		5.200b.06D1.fg73.j0
Loop Line S	Ø2306 mm	137 W		11831 lm		5.2003.07D1.fg73.j0
Loop Line S	Ø3000 mm	182 W		15775 lm		5.2003.08D1.fg73.j0
Loop Line S	Ø4100 mm	256 W		22183 lm		5.2003.09D1.fg73.j0
Loop Line S	Ø5100 mm	319 W		27606 lm		5.2003.10D1.fg73.j0
Loop Line S	Ø6000 mm	370 W		32042 lm		5.2003.11D1.fg73.j0

Strumień świetlny oprawy podany dla 4000K.  
Fixture lumen output data refer to 4000K.  
Lichtstrom der Leuchte spezifiziert für 4000K.

Central ceiling cup

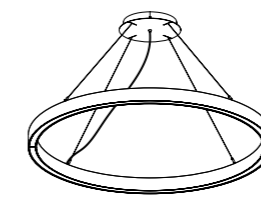

Ø614 - 1742 mm

Side ceiling cup

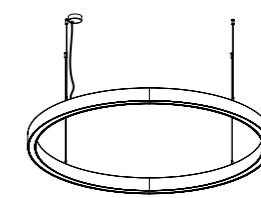

Ø614 - 6000 mm

85 mm

Ceiling cup	b	Driver	f	LED color	g	Diffuser	i	Finishing	j	j	
central	2	ON/OFF	1	830	2	satine	1	white (RAL9016)	4	sandy	D
side	3	DALI	2	840	3	microcrystal	2	black (RAL9005)	5	earth	E
						microprism	3	fog (RAL7038)	G	sage	A
						dark microcrystal	8	graphite (RAL7024)	H	cloudy	C
								saphire (RAL5003)	S	night	N
								forrest (RAL6005)	F	black dust	B
								wine (RAL3005)	W	volcano	V
								ochra	O	marrone	M



# Loop

Line S



**Loop Line (central)**  
S 1500

**Loop Line (side)**  
S 770

## Cechy | Features | Eigenschaften

LED | 3000K / 4000K | CRI>80 | SDCM ≤ 3 | 50000h L80 B10 | IP20 | ON/OFF DALI | 220 - 240V 50-60HZ |

### Colors:

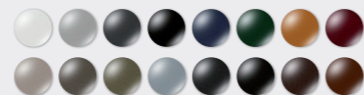

PL

**Montaż:** zwieszany

**Źródło światła:** PCB LED, 3000K / 4000K, CRI> 80, MacAdam ≤ 3,50000h L80B10.

**Moc oprawy:** wersja high efficiency (HE), wersja high output (HO).

**Dyfuzory:** satyna, mikrokryształiczny, ciemny mikrokryształiczny, mikropryzmatyczny.

**Rozsył światła:** bezpośredni / pośredni.

**Obudowa:** wytłaczany profil aluminiowy malowany proszkowo.

**Sterowanie:** ON/OFF lub DALI.

**Stopień ochrony:** IP20

EN

**Mounting:** suspended

**Light source:** PCB LED, 3000K / 4000K, CRI> 80, MacAdam ≤ 3,50000h L80B10.

**Luminaire power:** high efficiency (HE) version, high output (HO) version.

**Diffusers:** satin, microcrystal dark microcrystal, microprism.

**Light distribution:** direct / indirect.

**Housing:** powder coated extruded aluminum profile.

**Control:** ON / OFF or DALI.

**IP protection:** IP20

DE

**Installation:** abgependelt

**Lichtquelle:** PCB LED, 3000K / 4000K, CRI> 80, MacAdam ≤ 3,50000h L80B10.

**Leuchtenleistung:** hohe Effizienz (HE) Version, hohe Leistung (HO) Version.

**Diffusor:** satiniert, Microcrystale, dunkel Microcrystale, Mikroprisma.

**Lichtverteilung:** Direkt/Indirekt.

**Gehäuse:** Aluminium-Strangpressprofil, pulverbeschichtet.

**Steuerung:** EIN-AUS oder DALI.

**Schutzart:** IP20

## Loop Line S

DIRECT/INDIRECT



Version with LED CC HE (High Efficiency)



Version with LED CC HO (High Output)



Version with LED CC HO (High Output)

Type	Dimensions	Power	Luminaire flux *			Code
			satine/microcrystal	dark microcrystal UGR<19	microprism UGR<19	
Loop Line S	Ø614 mm	26+12 W	2975+1295 lm	2087+1295 lm	2398+1295 lm	5.200b.0111.fg6ij0
Loop Line S	Ø770mm	34+16 W	3966+1766 lm	2782+1766 lm	3197+1766 lm	5.200b.0211.fg6ij0
Loop Line S	Ø896 mm	39+18 W	4462+2002 lm	3130+2002 lm	3596+2002 lm	5.200b.0311.fg6ij0
Loop Line S	Ø1178 mm	52+25 W	5950+2708 lm	4174+2708 lm	4795+2708 lm	5.200b.0411.fg6ij0
Loop Line S	Ø1500 mm	69+33 W	7933+3651 lm	5565+3651 lm	6394+3651 lm	5.200b.0511.fg6ij0
Loop Line S	Ø1742 mm	77+38 W	8924+4122 lm	6260+4122 lm	7193+4122 lm	5.200b.0611.fg6ij0
Loop Line S	Ø2306 mm	103+50 W	11899+5476 lm	8347+5476 lm	9590+5476 lm	5.2003.0711.fg6ij0
Loop Line S	Ø3000 mm	138+65 W	15866+7066 lm	11130+7066 lm	12787+7066 lm	5.2003.0811.fg6ij0
Loop Line S	Ø4100 mm	193+90 W	22311+9892 lm	15651+9892 lm	17982+9892 lm	5.2003.0911.fg6ij0
Loop Line S	Ø5100 mm	241+112 W	27765+12247 lm	19477+12247 lm	22378+12247 lm	5.2003.1011.fg6ij0
Loop Line S	Ø6000 mm	280+129 W	32227+14131 lm	22607+14131 lm	25974+14131 lm	5.2003.1111.fg6ij0

  

Type	Dimensions	Power	Luminaire flux *		Code
			satine/microcrystal	dark microcrystal	
Loop Line S	Ø614 mm	52+24 W	5520+2523 lm	3790+2523 lm	5.200b.0111.fg7ij0
Loop Line S	Ø770mm	69+32 W	7361+3441 lm	4946+3441 lm	5.200b.0211.fg7ij0
Loop Line S	Ø896 mm	78+37 W	8281+3900 lm	5564+3900 lm	5.200b.0311.fg7ij0
Loop Line S	Ø1178 mm	104+50 W	11041+5276 lm	7419+5276 lm	5.200b.0411.fg7ij0
Loop Line S	Ø1500 mm	138+67 W	14721+7111 lm	9892+7111 lm	5.200b.0511.fg7ij0
Loop Line S	Ø1742 mm	156+75 W	16561+8029 lm	11128+8029 lm	5.200b.0611.fg7ij0
Loop Line S	Ø2306 mm	208+100 W	22082+10667 lm	14838+10667 lm	5.2003.0711.fg7ij0
Loop Line S	Ø3000 mm	277+129 W	29443+13764 lm	19784+13764 lm	5.2003.0811.fg7ij0
Loop Line S	Ø4100 mm	389+181 W	41404+19270 lm	27821+19270 lm	5.2003.0911.fg7ij0
Loop Line S	Ø5100 mm	484+224 W	51524+23858 lm	34621+19270 lm	5.2003.1011.fg7ij0
Loop Line S	Ø6000 mm	562+258 W	59805+27528 lm	40186+27528 lm	5.2003.1111.fg7ij0

Type	Dimensions	Power	Luminaire flux *		Code
			microprism UGR<19		
Loop Line S	Ø614 mm	34+24 W	2958+2523 lm		5.200b.0111.fg73j0
Loop Line S	Ø770mm	46+32 W	3944+3441 lm		5.200b.0211.fg73j0
Loop Line S	Ø896 mm	51+37 W	4437+3900 lm		5.200b.0311.fg73j0
Loop Line S	Ø1178 mm	68+50 W	5916+5276 lm		5.200b.0411.fg73j0
Loop Line S	Ø1500 mm	91+67 W	7887+7111 lm		5.200b.0511.fg73j0
Loop Line S	Ø1742 mm	102+75 W	8873+8029 lm		5.200b.0611.fg73j0
Loop Line S	Ø2306 mm	137+100 W	11831+10667 lm		5.2003.0711.fg73j0
Loop Line S	Ø3000 mm	182+129 W	15775+13764 lm		5.2003.0811.fg73j0
Loop Line S	Ø4100 mm	256+181 W	22183+19270 lm		5.2003.0911.fg73j0
Loop Line S	Ø5100 mm	319+224 W	27606+19270 lm		5.2003.1011.fg73j0
Loop Line S	Ø6000 mm	370+258 W	32042+27528 lm		5.2003.1111.fg73j0

Strumień świetlny oprawy podany dla 4000K. Fixture lumen output data refer to 4000K. Lichtstrom der Leuchte spezifiziert für 4000K.

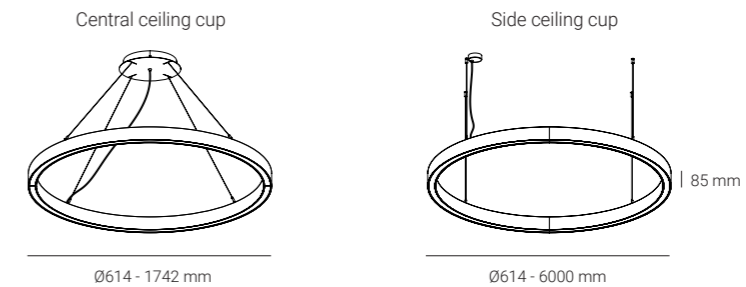

Ceiling cup	b	Driver	f	LED color	g	Diffuser	i	Finishing	j	j	
central	2	ON/OFF	1	830	2	satine	1	white (RAL9016)	4	sandy	D
side	3	DALI	2	840	3	microcrystal	2	black (RAL9005)	5	earth	E
						microprism	3	fog (RAL7038)	G	sage	A
						dark microcrystal	8	graphite (RAL7024)	H	cloudy	C
								saphire (RAL5003)	S	night	N
								forrest (RAL6005)	F	black dust	B
								wine (RAL3005)	W	volcano	V
								ochra	O	marrone	M









# Loop

## Chili C

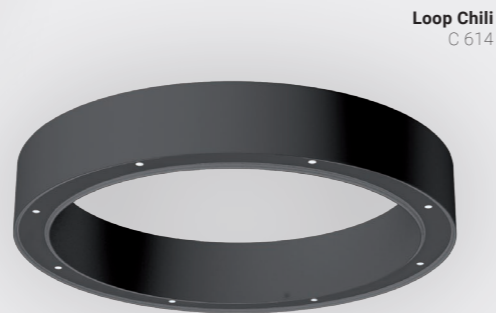

Loop Chili  
C 614

Loop Chili  
C 1500

### Cechy | Features | Eigenschaften

LED	3000K 4000K	CRI>80	SDCM ≤ 3	50000h L80 B10	IP20	ON/OFF DALI	220 - 240V 50-60HZ		CE
-----	----------------	--------	----------	-------------------	------	----------------	-----------------------	--	----

### Colors:

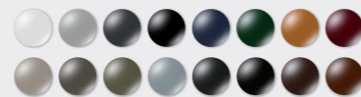

#### PL

**Montaż:** nabudowany.

**Źródło światła:** PCB LED, 3000K / 4000K, CRI> 80, MacAdam ≤ 3,50000h L80B10.

**Moc oprawy:** wersja high output (HO).

**Optyka:** soczewka 30°/60°.

**Rozsył światła:** bezpośredni.

**Obudowa:** wytłaczany profil aluminiowy malowany proszkowo.

**Sterowanie:** ON/OFF lub DALI.

**Stopień ochrony:** IP20

#### EN

**Mounting:** ceiling built-on.

**Light source:** PCB LED, 3000K / 4000K, CRI> 80, MacAdam ≤ 3,50000h L80B10.

**Luminaire power:** high output (HO) version.

**Optic:** lens 30°/60°.

**Light distribution:** direct.

**Housing:** powder coated extruded aluminum profile.

**Control:** ON / OFF or DALI.

**IP protection:** IP20

#### DE

**Installation:** angebaut.

**Lichtquelle:** PCB LED, 3000K / 4000K, CRI> 80, MacAdam ≤ 3,50000h L80B10.

**Leuchtenleistung:** hohe Leistung (HO) Version.

**Optik:** Linse 30°/60°.

**Lichtverteilung:** Direkt.

**Gehäuse:** Aluminium-Strangpressprofil, pulverbeschichtet.

**Steuerung:** EIN-AUS oder DALI.

**Schutzart:** IP20

### Loop Chili C DIRECT



Version with  
LED CC HO  
(High Output)



Type	Dimensions	Power	Luminaire flux *		Code
			lens 30° UGR<19	lens 60° UGR<19	
Loop Chili C	Ø614 mm	18 W	1560 lm	1600 lm	5.2011.01C1.fg7i.j0
Loop Chili C	Ø770 mm	22 W	1950 lm	2000 lm	5.2011.02C1.fg7i.j0
Loop Chili C	Ø896 mm	27 W	2340 lm	2400 lm	5.2011.03C1.fg7i.j0
Loop Chili C	Ø1178 mm	36 W	3120 lm	3200 lm	5.2011.04C1.fg7i.j0
Loop Chili C	Ø1500 mm	45 W	3900 lm	4000+lm	5.2011.05C1.fg7i.j0
Loop Chili C	Ø1742 mm	54 W	4680 lm	4800 lm	5.2011.06C1.fg7i.j0
Loop Chili C	Ø2306 mm	72 W	6240 lm	6400 lm	5.2011.07C1.fg7i.j0
Loop Chili C	Ø3000 mm	90 W	7800 lm	8000 lm	5.2011.08C1.fg7i.j0
Loop Chili C	Ø4100 mm	121 W	10530 lm	10800 lm	5.2011.09C1.fg7i.j0
Loop Chili C	Ø5100 mm	143 W	12480 lm	12800 lm	5.2011.10C1.fg7i.j0
Loop Chili C	Ø6000 mm	179 W	15600 lm	16000 lm	5.2011.11C1.fg7i.j0

Strumień świetlny oprawy podany dla 4000K.  
Fixture lumen output data refer to 4000K.  
Lichtstrom der Leuchte spezifiziert für 4000K.

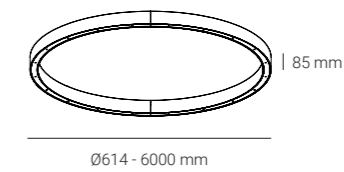

Ceiling cup	b	Driver	f	LED color	g	Beam angle	i	Finishing	j	k	
central	2	ON/OFF	1	830	2	30°	M	white (RAL9016)	4	sandy	D
side	3	DALI	2	840	3	60°	W	black (RAL9005)	5	earth	E
								fog (RAL703B)	G	sage	A
								graphite (RAL7024)	H	cloudy	C
								saphire (RAL5003)	S	night	N
								forrest (RAL6005)	F	black dust	B
								wine (RAL3005)	W	volcano	V
								ochra	O	marrone	M



# Loop Chili S



Loop Chili (side)  
S 1178

Loop Chili (central)  
S 614

## Cechy | Features | Eigenschaften

LED	3000K 4000K	CRI>80	SDCM ≤ 3	50000h L80 B10	IP20	ON/OFF DALI	220 - 240V 50-60HZ		CE
-----	----------------	--------	----------	-------------------	------	----------------	-----------------------	--	----

### Colors:

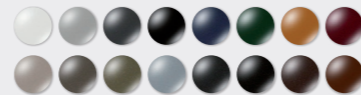

PL

**Montaż:** zwieszany

**Źródło światła:** PCB LED, 3000K / 4000K, CRI> 80, MacAdam ≤ 3,50000h L80B10.

**Moc oprawy:** wersja high output (HO).

**Optyka:** soczewka 30°/60°.

**Rozsył światła:** bezpośredni, bezpośredni / pośredni.

**Obudowa:** wytłaczany profil aluminiowy malowany proszkowo.

**Stewowanie:** ON/OFF lub DALI.

**Stopień ochrony:** IP20

EN

**Mounting:** suspended

**Light source:** PCB LED, 3000K / 4000K, CRI> 80, MacAdam ≤ 3,50000h L80B10.

**Luminaire power:** high output (HO) version.

**Optic:** lens 30°/60°.

**Light distribution:** direct, direct / indirect.

**Housing:** powder coated extruded aluminum profile.

**Control:** ON / OFF or DALI.

**IP protection:** IP20

DE

**Installation:** abgependelt

**Lichtquelle:** PCB LED, 3000K / 4000K, CRI> 80, MacAdam ≤ 3,50000h L80B10.

**Leuchtenleistung:** hohe Leistung (HO) Version.

**Optik:** 30°/60°.

**Lichtverteilung:** Direkt, Direkt/ Indirekt.

**Gehäuse:** Aluminium-Strangpressprofil, pulverbeschichtet.

**Steuerung:** EIN-AUS oder DALI.

**Schutzart:** IP20

## Loop Chili S DIRECT



Version with  
LED CC HO  
(High Output)

Type	Dimensions	Power	Luminaire flux *		Code
			lens 30° UGR<19	lens 60° UGR<19	
Loop Chili S	Ø614 mm	18 W	1560 lm	1600 lm	5.201b.01D1.fg7i.j0
Loop Chili S	Ø770 mm	22 W	1950 lm	2000 lm	5.201b.02D1.fg7i.j0
Loop Chili S	Ø896 mm	27 W	2340 lm	2400 lm	5.201b.03D1.fg7i.j0
Loop Chili S	Ø1178 mm	36 W	3120 lm	3200 lm	5.201b.04D1.fg7i.j0
Loop Chili S	Ø1500 mm	45 W	3900 lm	4000+lm	5.201b.05D1.fg7i.j0
Loop Chili S	Ø1742 mm	54 W	4680 lm	4800 lm	5.201b.06D1.fg7i.j0
Loop Chili S	Ø2306 mm	72 W	6240 lm	6400 lm	5.2013.07D1.fg7i.j0
Loop Chili S	Ø3000 mm	90 W	7800 lm	8000 lm	5.2013.08D1.fg7i.j0
Loop Chili S	Ø4100 mm	121 W	10530 lm	10800 lm	5.2013.09D1.fg7i.j0
Loop Chili S	Ø5100 mm	143 W	12480 lm	12800 lm	5.2013.10D1.fg7i.j0
Loop Chili S	Ø6000 mm	179 W	15600 lm	16000 lm	5.2013.11D1.fg7i.j0

## Loop Chili S DIRECT/INDIRECT



Version with  
LED CC HO  
(High Output)

Type	Dimensions	Power	Luminaire flux *		Code
			lens 30° UGR<19	lens 60° UGR<19	
Loop Chili S	Ø614 mm	18+12 W	1560+1295 lm	1600+1295 lm	5.201b.0111.fg7i.j0
Loop Chili S	Ø770 mm	22+16 W	1950+1766 lm	2000+1766 lm	5.201b.0211.fg7i.j0
Loop Chili S	Ø896 mm	27+18 W	2340+2002 lm	2400+2002 lm	5.201b.0311.fg7i.j0
Loop Chili S	Ø1178 mm	36+25 W	3120+2708 lm	3200+2708 lm	5.201b.0411.fg7i.j0
Loop Chili S	Ø1500 mm	45+33 W	3900+3651 lm	4000+3651 lm	5.201b.0511.fg7i.j0
Loop Chili S	Ø1742 mm	54+38 W	4680+4122 lm	4800+4122 lm	5.201b.0611.fg7i.j0
Loop Chili S	Ø2306 mm	72+50 W	6240+5476 lm	6400+5476 lm	5.2013.0711.fg7i.j0
Loop Chili S	Ø3000 mm	90+65 W	7800+7066 lm	8000+7066 lm	5.2013.0811.fg7i.j0
Loop Chili S	Ø4100 mm	121+90 W	10530+9892 lm	10800+9892 lm	5.2013.0911.fg7i.j0
Loop Chili S	Ø5100 mm	143+112 W	12480+12247 lm	12800+12247 lm	5.2013.1011.fg7i.j0
Loop Chili S	Ø6000 mm	179+129 W	15600+14131 lm	16000+14131 lm	5.2013.1111.fg7i.j0

Strumień świetlny oprawy podany dla 4000K.  
Fixture lumen output data refer to 4000K.  
Lichtstrom der Leuchte spezifiziert für 4000K.

Central ceiling cup

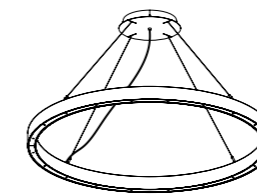

Ø614 - 1742 mm

Side ceiling cup

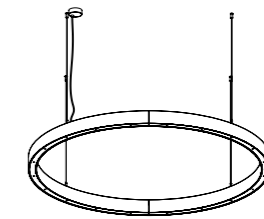

Ø614 - 6000 mm

85 mm

Ceiling cup	b	Driver	f	LED color	g	Beam angle	i	Finishing	j	j	
central	2	ON/OFF	1	830	2	30°	M	white (RAL9016)	4	sandy	D
side	3	DALI	2	840	3	60°	W	black (RAL9005)	5	earth	E
								fog (RAL703B)	G	sage	A
								graphite (RAL7024)	H	cloudy	C
								saphire (RAL5003)	S	night	N
								forrest (RAL6005)	F	black dust	B
								wine (RAL3005)	W	volcano	V
								ochra	O	marrone	M







**ORGANIC LIGHTING**

ul. 1 Maja 46a  
05-555 Tarczyn, Poland  
tel: +48 22 736 73 00  
info@organiclighting.eu



